

# USER MANUAL

## Adash A4300 – VA3 Pro Ex



# Content:

|   |           |
|---|-----------|
| <b>Introduction: basic instructions .....</b>             | <b>5</b>  |
| A4300 VA3 Pro Ex – configuration .....                    | 5         |
| General warnings .....                                    | 5         |
| Number of certificate .....                               | 5         |
| Specification according to 94/9/EC (ATEX) directive ..... | 5         |
| Ambient temperature (operation and storage) .....         | 6         |
| Certificated accessories .....                            | 6         |
| Signal specifications .....                               | 6         |
| Instrument sticker .....                                  | 7         |
| Using the instrument .....                                | 7         |
| Batteries and charging.....                               | 8         |
| <b>Hardware description .....</b>                         | <b>9</b>  |
| DSP board.....  | 9         |
| Top panel .....   | 9         |
| CPU status LED .....                                      | 9         |
| Connection to the computer.....                           | 10        |
| Bottom panel.....   | 11        |
| <b>Input channels .....</b>                               | <b>12</b> |
| IN1 input.....  | 12        |
| IN2 input.....  | 12        |
| TRIG input.....   | 12        |
| Standard cable specifications .....                       | 13        |
| IN1 Socket.....   | 13        |
| IN2 Socket.....   | 13        |
| TRIG Socket.....  | 13        |
| <b>First steps with VA3 device .....</b>                  | <b>14</b> |
| Turn on/off the device.....                               | 14        |
| Switch off – emergency .....                              | 14        |
| Battery .....   | 14        |
| Memory capacity warning.....                              | 15        |
| <b>How to work with the device menu and lists.....</b>    | <b>16</b> |
| Special buttons.....                                      | 16        |
| Item selection .....                                      | 16        |
| Lists.....  | 17        |
| <b>Main menu .....</b>                                    | <b>18</b> |
| Trigger.....  | 18        |
| Sensors .....   | 20        |
| AC sensors.....   | 21        |
| DC sensors .....  | 23        |
| Tacho / External .....                                    | 24        |
| Global.....   | 26        |
| Date and time.....  | 29        |
| Update .....  | 30        |
| Export Logs.....  | 30        |
| Screenshot.....   | 30        |
| <b>Update of the new measurement module(s).....</b>       | <b>32</b> |
| <b>Info .....</b>   | <b>33</b> |
| <b>Speed detection .....</b>                              | <b>34</b> |
| <b>Meter .....</b>  | <b>35</b> |
| Settings .....  | 35        |

|                                       |           |
|---------------------------------------|-----------|
| Sensors settings.....                 | 36        |
| Unit settings .....                   | 36        |
| Measurement .....                     | 36        |
| Status bar.....                       | 36        |
| Measurement screens.....              | 37        |
| <b>FASIT .....</b>                    | <b>39</b> |
| Settings .....                        | 39        |
| Sensors Settings .....                | 40        |
| Units.....                            | 40        |
| Measurement .....                     | 40        |
| FASIT screen .....                    | 40        |
| <b>Strobo .....</b>                   | <b>42</b> |
| Easy access .....                     | 42        |
| <b>Analyzer.....</b>                  | <b>43</b> |
| Basic concepts .....                  | 43        |
| Analyzer menu .....                   | 43        |
| New Meas (Basic, Advanced).....       | 44        |
| New Meas (Basic) .....                | 44        |
| New Meas (Advanced) .....             | 45        |
| Next Meas functions .....             | 49        |
| Functions for Set .....               | 53        |
| Export.....                           | 54        |
| Graph Max/Min.....                    | 54        |
| Graph Properties .....                | 55        |
| Analyzer Buttons .....                | 56        |
| FASIT .....                           | 57        |
| Overall.....                          | 57        |
| Spectrum.....                         | 58        |
| Time .....                            | 59        |
| g-demod overall.....                  | 59        |
| g-demod spectrum .....                | 60        |
| g-demod time .....                    | 60        |
| amp+phase .....                       | 60        |
| Orbit .....                           | 61        |
| Speed.....                            | 61        |
| ACMT .....                            | 62        |
| Orders .....                          | 62        |
| Phase shift .....                     | 63        |
| DC.....                               | 63        |
| IR temperature .....                  | 63        |
| Center line.....                      | 64        |
| S-max.....                            | 64        |
| Ultrasound.....                       | 64        |
| Record .....                          | 65        |
| <b>Route.....</b>                     | <b>66</b> |
| Load the route to the instrument..... | 66        |
| Route creation in VA3 device .....    | 68        |
| Route readings.....                   | 68        |
| Downloading the route to the PC ..... | 70        |
| Route Meas Mode .....                 | 70        |
| Reference values .....                | 70        |
| Manual entry .....                    | 71        |
| Notes.....                            | 71        |
| Speed in the route .....              | 72        |
| Limits.....                           | 72        |

|   |            |
|---|------------|
| Route Buttons .....                                   | 73         |
| <b>Balancer.....</b>                                  | <b>74</b>  |
| Planes and points.....                                | 74         |
| Project.....  | 74         |
| Project list.....                                     | 74         |
| New project.....                                      | 75         |
| Balancer Menu.....                                    | 75         |
| Balancer Settings.....                                | 76         |
| Units Settings.....                                   | 78         |
| Rotor Settings.....                                   | 78         |
| Single plane balancing.....                           | 79         |
| Dual plane balancing.....                             | 85         |
| Balancing errors.....                                 | 88         |
| <b>Recorder.....</b>                                  | <b>90</b>  |
| Record length.....                                    | 90         |
| Record screen.....                                    | 90         |
| Project screen.....                                   | 91         |
| Record settings.....                                  | 91         |
| Sensor settings.....                                  | 92         |
| Recording.....  | 92         |
| Preview of recorded data.....                         | 92         |
| Record analysis.....                                  | 93         |
| <b>Run Up.....</b>                                    | <b>94</b>  |
| Measurement control.....                              | 94         |
| Measurement setting.....                              | 94         |
| Measurement.....                                      | 94         |
| Trends.....   | 95         |
| Delete trends.....                                    | 95         |
| <b>Ultrasound.....</b>                                | <b>96</b>  |
| Sensor setting.....                                   | 96         |
| Settings.....   | 96         |
| Measurement.....                                      | 96         |
| <b>Appendix A: Technical specifications.....</b>      | <b>97</b>  |
| <b>Appendix B: Vibration standards.....</b>           | <b>98</b>  |
| Adash Limit Values.....                               | 98         |
| ISO 10816/20816 limit values.....                     | 100        |
| <b>Appendix C: Phase measurement conversions.....</b> | <b>102</b> |
| Single channel measurement with tacho.....            | 102        |
| Dual channel measurement.....                         | 105        |
| Last reminder.....                                    | 105        |

## **Introduction: basic instructions**

The A4300 VA3 Pro Ex is the newest addition to our range of portable devices for vibration diagnostics and machine balancing.

There are **2 signal inputs** and **1 tacho/trigger input**. Input 2 offers connectivity to a triaxial sensor; therefore all 3 channels can be measured simultaneously. The expert system developed by Adash can automatically detect machine faults such as **unbalance, looseness, misalignment and bearing faults**.

There is a non-contact IR temperature sensor (for immediate bearing temperature measurement) and a LED stroboscope/torch.

The A4300 VA3 Pro Ex is designed for one-handed operation. With a weight of just 760g and a battery life of more than 6 hours of operation, the unit is suitable for long route measurements.

### **A4300 VA3 Pro Ex – configuration**

The A4300 VA3 Pro Ex instrument can be configured according to your requirements by choosing optional modules: *analyzer, route, balancer, recorder, run up or ultrasound*. Optional modules can be purchased also additionally and downloaded to the instrument without the need of sending it back to the factory.

At the moment there are **9 modules** available. The modules FASIT (Expert system), Stroboscope and Meter are included in every unit.

**The modules:** Analyzer, Route, Balancer, Recorder and Run Up are optional and it is up to you if you wish to have them in your A4300 VA3 Pro Ex.

**Before you turn on your device, you need to pay attention to the following information.**

**Ignoring any recommendations mentioned below may cause failure of the device.  
Operating with a power higher than 24 V can cause an accident.**

### **General warnings**

AC, DC channels - voltage higher than  $\pm 25$  V (peak) can damage the instrument.

Only suitable ICP powered sensors can be connected to the AC signal inputs.

If a measurement without ICP power is required, ICP power must be switched off. You can damage the external signal source, which is not protected against ICP powering.

Use only original cables designed for connection with the sensor.

Use only the original charger with the original connector.

Never use any reduction to connect the charger with the instrument.

Use the charger only if the instrument is turned off. Only charge the instrument indoors, in dry environment without vibrations.

A long push and hold of the POWER button turn the instrument off incorrectly. Data could be lost.

If you are unsure, contact your distributor or the manufacturer.

### **Number of certificate**

**FTZÚ 21 ATEX 0040X**

**Specification according to 94/9/EC (ATEX) directive**



**II 3G Ex ic op is IIC T3 Gc**

|              |  |
|--------------|--|
| <b>II</b>    | non-mining   |
| <b>3</b>     | Zone 2   |
| <b>G</b>     | Gas atmosphere   |
| <b>Ex ic</b> | Principle of protection – Intrinsic Safety EN 60079-11, Zone 2   |
| <b>op is</b> | the optical beam of the LED will not cause ignition              |
| <b>IIC</b>   | All gasses with temperature classes T1 to T3, see IEC 80079-20-1 |
| <b>T3</b>    | Max. surface temperature (during failure) 200°C.                 |
| <b>Gc</b>    | EPL (Equipment protection level) – Zone 2                        |

Zone 2 – the occurrence of an explosive atmosphere is unlikely, but cannot be ruled out. If it occurs, then only for a short time. this is a probability of less than 0.1% of operating time or less than 10 hours per year in the case of continuous operation.

The instrument is certificated for Zone 2 hazardous areas and must not be used in Zones 0 and 1.

*Ambient temperature (operation and storage)*

$$T_a = -10 \text{ to } +50^\circ\text{C}.$$

When using the recommended speed probe Mini VLS 210/ia, the maximum permitted ambient temperature is +40°C

## ***Certificated accessories***

### ***Accelerometers***

CTC AC90X, AC91X, AC95X or AC905.

Use only with original cable.

### ***Speed probe***

Mini VLS 210/ia.

Use only with original cable.

Maximum ambient temperature,  $T_a \text{ max} = +40^\circ\text{C}$ .

### ***Antistatic cover***

For carrying the device on the shoulder or behind the waist, a cover is supplied as an optional accessory, which is made of antistatic VINYTOL 752 DUO NV leather. The case is equipped with a removable strap made of the same material and a belt clip. The device is inserted into the package and secured with Velcro.

**Attention!** The cover is a universal accessory that covers the production label with the device specification. To access the data on the label, the device must be removed from the packaging.

Unapproved standard packaging that comes with a different type of device cannot be used for potentially explosive atmospheres!

## ***Signal specifications***

### ***IN1, IN2 connectors for accelerometer***

| <b>Quantity</b> | <b>Description</b> | <b>max. value</b> | <b>standard value</b> |
|-----------------|--------------------|-------------------|-----------------------|
| Uo              | Output voltage     | <25.2V            | 21.5V                 |
| Io              | Output current     | <58mA             | 3.8mA                 |
| Lo              | Sensor inductance  | <60uH             | 51uH                  |
| Co              | Sensor capacity    | <100nF            | 70nF                  |

**TRIG connector for speed probe**

| Quantity       | Description       | max. value | standard value |
|----------------|-------------------|------------|----------------|
| U <sub>o</sub> | Output voltage    | <6.0V      | 5.0V           |
| I <sub>o</sub> | Output current    | <425mA     | 100mA          |
| L <sub>o</sub> | Sensor capacity   | <100uH     | 0uH            |
| C <sub>o</sub> | Sensor inductance | <10uF      | 0uF            |

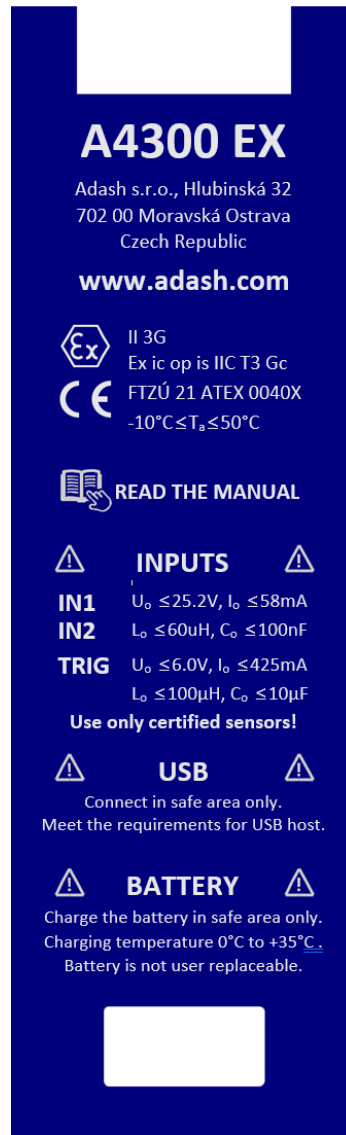
**Instrument sticker****Using the instrument****Grounding**

The operator must be grounded and the instrument is thus grounded through the operator.

**Charging**

Charge only with the supplied FRIWO FW7290 GPP18Li/8.4V/1.5A charger. Charge only in indoor areas with a non-explosive environment. The ambient temperature during charging must not exceed 0-35°C.

## **Data transfer into PC**

The instrument can only be connected to the host PC in a non-explosive environment. The power supply of the connected PC must comply with IEC60950, IEC61010-1 or must be powered by a battery.

## **Warning**

Only certificated sensors, cables and other accessories such as a protective cover can be connected to the instrument. Disassembling the instrument, any repairs or replacement of the battery by the user, sticking labels and foil on the antistatic surfaces of the instrument, cleaning the instrument with aggressive cleaning agents (alcohol, gasoline, etc.) or any other intervention that could cause a violation of the intrinsic safety of the device is prohibited.

## **Batteries and charging**

**Use only the original charger. If you need new one, contact your dealer.**

The socket for the external charger (instrument accessory) is on the bottom side of the instrument.

**The charger contains LED indication:**

**orange:** charger disconnected from unit

**quick green flashes (several times per second):** charging in process

**slow green flashes (once per second):** unit charged

**slow orange flashes (once per second):** pre-charging of deeply discharged battery (it can take hours, it depends on the level of the discharge)

**continuous green:** disconnect the charger

**quick orange flashes:** charging error

The battery indicator on instrument screen doesn't correctly display the charge level during the charging. The indicator checks in this case the voltage from charger not from battery. Always disconnect the charger to check the charge level.

Normally full charging takes 5 hours. It takes longer time, when unit is switched on during charging.

Never do short circuit the charger connectors.

Recommended charging temperature is 0-40°C (32-104°F) (0 – 35°C (32-95°F) for Ex version)

Very high temperature over 50°C (122°F) decreases battery life. Don't leave the instrument on direct sun light or on other heat source.

The battery capacity decreases with low temperatures (e.g. on –10°C (14°F) only 70% capacity is available). Keep the unit in normal temperature before you begin measurement.

Always check if the charging indication is correct before connecting the charger and before disconnecting it.

Do not leave the charger connected to the instrument after it had been charged.

Do not use the charger during measurement or while the instrument is turned on.

Don't leave the unit uncharged for the long time. The battery could be discharged completely. If you do not use the unit, charge it regularly every 6 months.

### **Note!**

The VA3 Pro Ex unit is continuously developed and new functions and features are added quite often. Such additions require changes in the manual and those changes are very time consuming for us. That is why we do not change all the pictures in the manual with each new version. We have not changed some pictures in the manual although they have been changed in the instrument already. This has only been done on places where such pictures have no consequence on the new function.



## **Hardware description**

Basic technical terms and hardware description of the device is included in this chapter.

### **DSP board**

The DSP (*Digital Signal Processing*) board is the most important part of the device. The special chip carries out all necessary operations which are required for achieving 3 channel synchronous data measurement.

The DSP status LED is the right-side LED on the top right corner. It allows the operator to monitor the DSP board.



Several states can appear:

- **Flashing green with 0.25 sec** time interval (4Hz, four times per sec) – the measurement is running.
- **Flashing green with 1 sec** time interval – STANDBY, the measurement is not running.
- **Red** – the DSP board is not working properly.

### **Top panel**

Top panel includes 3 input channels (2 signal inputs and 1 tacho input), infrared (IR) temperature sensor, LED stroboscope/flashlight and connector to the computer (for data transferring).

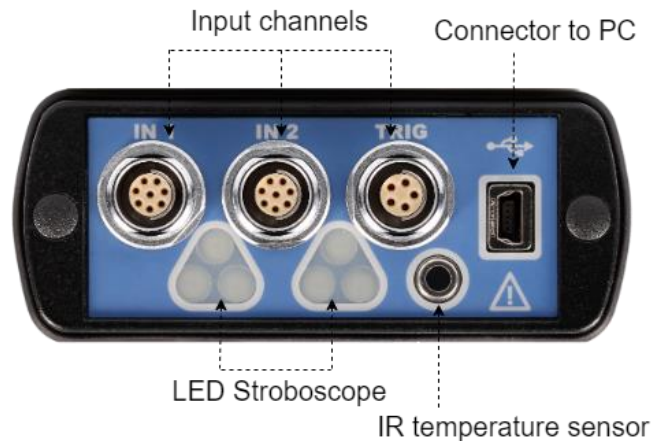

### **CPU status LED**

The CPU board contains the CPU chip. The CPU status LED is the left-side LED on the top right corner. It allows the operator to monitor the CPU. If this LED blinks (like a heartbeat) the CPU is working properly.



## Connection to the computer

Use the mini-USB cable to connect the device to the computer (*older VA3 PRO has micro-USB connector*). This cable is a standard accessory of the VA3 Pro set. There is a mini-USB port on the *top side* of the VA3 device for the connection.



When the VA3 is connected correctly to the computer (or switched off), the new device (new flash drive) appears on the computer. The name is **VA3\_DISC**. If this operation fails, switch off the unit and try to connect it again.

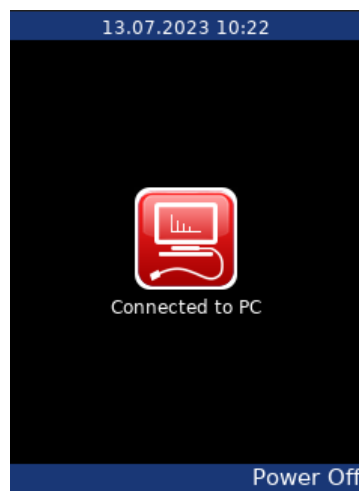

**Note!** VA3 Pro unit should be really switched off or in the main menu screen when you connect it to the computer. Otherwise, the **VA3 cannot be seen in flash drives connected to computer** (e.g., when you have screen with analyzer module opened with some measurement – VA3 is not shown in PC as connected device). When VA3 is not correctly connected to computer, you can see just a small notice in the left top corner 'PC...'. You cannot see VA3 folder in your PC.

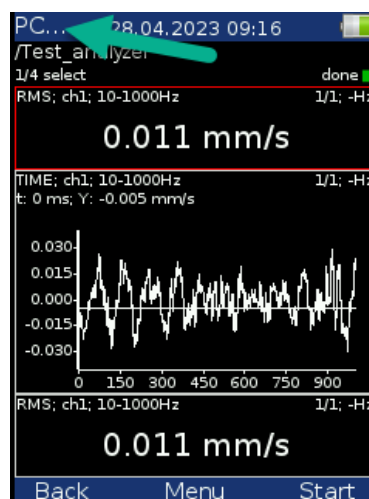

**Always use the 'Safely remove' hardware function before disconnecting the VA3 Pro unit from the computer!**

The **va3** folder (*case sensitive*) is automatically created on VA3\_DISC.

**Bottom panel**

You connect charger here on the bottom panel of VA3 device.

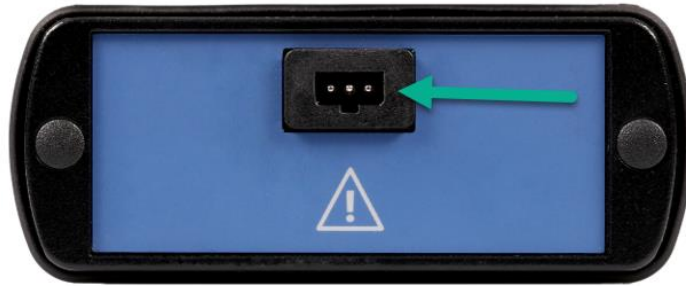

## Input channels

The inputs labeled IN1, IN2 are used for AC/DC signals. The input labeled TRIG is used for trigger signals, usually tacho (speed probe). All inputs have several pins. IN2 allows the user to connect a tri-axial sensor. The AC inputs allow the measurement of a maximum voltage peak of  $\pm 12V$ . The DC inputs allow the measurement of a maximum voltage peak of  $\pm 24V$ .



### **IN1 input**

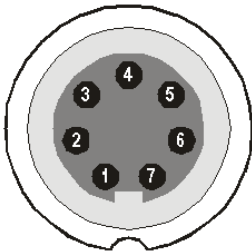

- 1 – CH1 AC/DC INPUT
- 2 – GROUND
- 3 – NOT USED
- 4 – SHIELDING
- 5 – NOT USED
- 6 – NOT USED
- 7 – +5 V DC OUTPUT (max 100 mA) for ultrasound sensor powering

**Warning!** Pin 7 of IN1 socket (ultrasound sensor powering) is internally connected with pin 4 of TRIG socket (tacho sensor powering).

### **IN2 input**

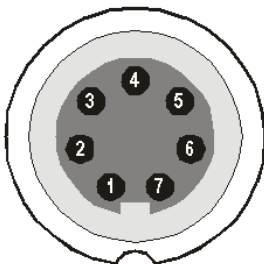

- 1 – CH2 AC/DC INPUT
- 2 – GROUND
- 3 – CH1 AC/DC INPUT
- 4 – SHIELDING
- 5 – CH3 AC/DC INPUT
- 6 – NOT USED
- 7 – NOT USED

### **TRIG input**

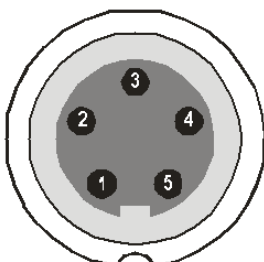

- 1 – GROUND
- 2 – GROUND
- 3 – GROUND
- 4 – +5 V OUTPUT / 100 mA for the tacho power supply
- 5 – TRIG INPUT - for tacho signal

**Warning!** Pin 7 of IN1 socket (ultrasound sensor powering) is internally connected with pin 4 of TRIG socket (tacho sensor powering).

## Standard cable specifications

Sensor signal – pin number 1

Ground – pin number 2

When you use the standard cable:

In the **IN1** socket - the signal is measured on CH1.

In the **IN2** socket - the signal is measured on CH2.

If you want to use **the tri-axial sensor**, then you should use the IN2 socket (pins 3,1,5) + ground (pin 2). You need a special cable for this purpose.

## Input channels – ODU variation

### IN1 Socket

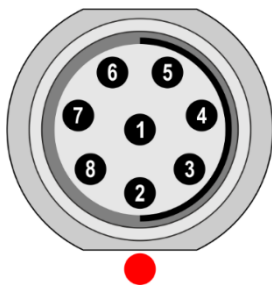

- 1 – GND
- 2 – +5V/0.1A
- 3 – NC
- 4 – NC
- 5 – SHLD
- 6 – NC
- 7 – **GND**
- 8 – **AC1 / DC1**

**Warning!** Pin 2 of IN1 socket (ultrasound sensor powering) is internally connected with pin 2 of TRIG socket (tacho sensor powering).

### IN2 Socket

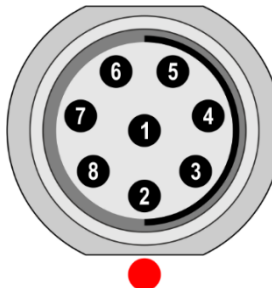

- 1 – GND
- 2 – NC
- 3 – NC
- 4 – AC3 / DC3
- 5 – SHLD
- 6 – AC1 / DC1
- 7 – **GND**
- 8 – AC2 / DC2

**Pay attention** to possibility of connecting all three channels to **IN2**.

### TRIG Socket

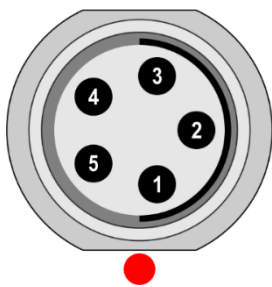

- 1 – TRIG
- 2 – +5V/0.1A
- 3 – SHLD
- 4 – GND
- 5 – GND

**Warning!** Pin 2 of IN1 socket (ultrasound sensor powering) is internally connected with pin 2 of TRIG socket (tacho sensor powering).

## **First steps with VA3 device**

You will learn first basic steps with VA3 device in this chapter. We mean (by basic steps) turn on/off the device or which color is indicating full battery state, etc.

### **Turn on/off the device**

Use the **POWER** button (**F3**) to turn on the device.

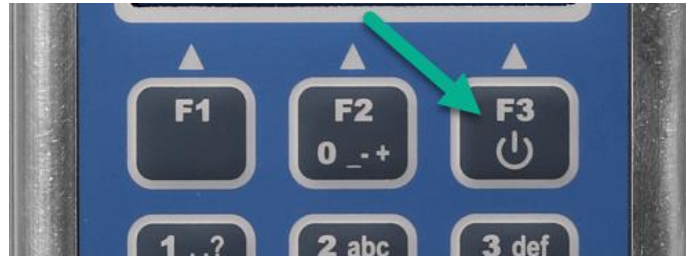

Push and hold this **F3** button until the right-hand LED on the front panel changes color from orange to green.



Turn off the device with the same **F3** button. Press this button and confirm following window 'Power off the instrument' by pressing **Yes** (**F1** button).



### **Switch off – emergency**

This is not the correct method of switching off the instrument. **Using it can cause data corruption.** Use this method only in cases when it is absolutely necessary.

Push and hold the **POWER** button for about 5 seconds, then release the button. The instrument will switch off.

### **Battery**

The information about % of battery lifetime is displayed on the top right corner of the display. When the battery is charged **more than 25% the battery symbol is green.**



When the battery is charged **5-25%**, the **yellow** symbol is used. Under **5%**, the **red** symbol appears.

### ***Memory capacity warning***

If the memory capacity warning appears (see the picture below), you need to free up some memory space by removing some measurements or routes.



# How to work with the device menu and lists

## Special buttons

F1, F2 and F3 buttons are on the top of the keyboard. These buttons have various functions depending on the actual running process.

The description of their function is displayed at the bottom of the screen, directly above them. See following example: F1 means **Back** and F3 means **OK** (F2 has no function in this example).



## Item selection

Before starting the measurements, you need to define few parameters. You have to set them in the 'Menu' item. Procedure is the same for all the menu items. As an example, we will describe sensor properties definition.

Press F2 button for showing Menu options.

Select the **Sensors** item with arrow (8 button) and press **OK** (5 button). The sensors properties menu appears.



Use the **arrow buttons** for item selection from this menu and then press **OK** button (we choose option AC1). Now second menu appears.





Use again the **arrows** for the item selection. Press right arrow button to display possible parameters of the selected item, e.g., for sensitivity.

Use the arrow button for sensitivity selection (**1, 10, 100** or **user**). Press **OK** or **right arrow** button to confirm this option.

Press **Back (F1)** or **left arrow** to escape.

In most cases you would want to enter the sensitivity according to **the real sensor sensitivity** (e.g., 96,8 mV/g). You can do it with *user defined values*.

Select the '**user**' option and press **OK**. The next window appears and the buttons gets the numerical values entry functions. Enter the required value.



The F1 button **changes the mode** of keyboard. Two modes are available. The numerical and edit modes. In edit mode you can use arrows to move in field and **Delete (9)** and **Backspace (7)**.

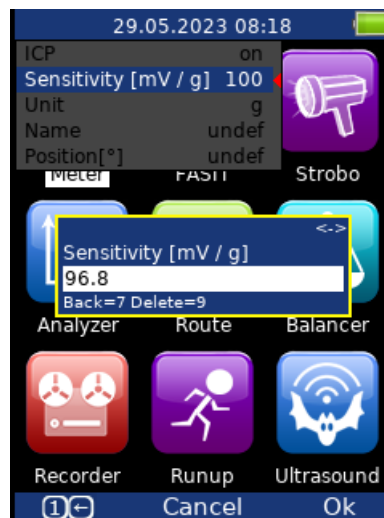

## Lists

**Key up (number 2 button)**

**Key down (8 button)**

**Key 1 (1 button)**

**Key 3 (3 button)**

select upper item

select lower item

page up (first item on the list)

page down (last item on the list)

## Main menu

Press **F2** for the main menu on the main screen. You get following window.



### **Trigger**

First option in main menu is **trigger**. Confirm this option with **OK** button and you get menu for trigger. You find following items in this trigger menu.

**Note!** Trigger basically determines when the measurement is started.



### **Trigger Mode**

**single**

You start the measurement and only one reading is taken and displayed.

**retrig**

When you use the analogue oscilloscope, you always see the current signal on the screen. The retrig mode means a similar thing. The reading repeats until you press the **Stop** button. Select the **single** option when you only want one reading.

### **Runup Mode**

Defines how often the data will be taken in the runup mode.

**asap**

The next measurement is taken immediately after the previous measurement without any delay.

**manual**

The user starts next measurement manually.

**speed**

The next measurement is taken when the speed is significantly different from the previous measurement speed. The user defines in **Speed change** item, what it is significant

change (this option is in trigger menu right below the Runup Mode – significant change is set in **Hz** – this option is greyed out in the picture above as runup mode is not set to speed value).

- time** All measurements are taken with the same time interval between them. The time interval length is defined in **Time Change** (it is fourth item in trigger menu shown in the picture above – time change is set in **s**).
- time or speed** This option is the combination of two options: speed and time. The next measurement is taken when one of them is changed more than the value set in **Speed change** or **Time Change**.

### **Speed change**

See **Runup Mode: speed** (the previous section).

### **Time change(s)**

See **Runup Mode: time** (the previous section)

### **Trigger Source**

Every measurement must be triggered (it means started). When you press the Enter button for taking the measurement, you run only the initialization. When everything is ready to take the data, then the Trigger Source item is applied.

In *Runup* module, the frequency of measurements is controlled by Runup Mode at first. Then the Trigger Source is applied.

- freerun** The measurement process begins immediately (after pressing the Start button - Analyzer module).
- external** The measurement process begins, when the external signal (voltage level higher than value defined in External Trig Level) appears on the trigger input. Such a signal may be generated when the machine starts to work, for example. This type of signal is usually created in the control system.
- manual** The measurement process begins after pressing the **Start** button and then the **OK** button. The **first** press (Start) is for preparation, the **second** (OK) is for triggering.
- manual sequential** Similar to manual but every reading for averaging must be started separately. E.g. when AVG=10, then the **OK** button must be pressed 10 times.
- amplitude** The measurement process begins when the signal level exceeds the **Ampl Trig Level**, which is also set by the user in this menu. Both – positive (rising edge) and negative (falling edge) levels – are accepted. It means, entering e.g., 5g will trigger on 5g. The signal amplitude is taken directly from the sensor input, no additional filtering is applied.

#### **Trigger source - examples:**

- *the level is set to 100mV* – triggered when the rising signal goes from e.g.99mV to 101mV
- *the level is set to -100mV* – triggered when the falling signal goes from e.g.-99mV to -101mV

- tacho** Measurement is triggered when signal on TRIG input crosses the Trig Level value defined in the Tacho / External menu. The tacho is special case of an external trigger. When we talk about the tacho, we mean the signal (usually like TTL) which contains one or several pulses during one rotation of the shaft. It can also be understood like a series of single external pulses.

**Note!** During averaging, tacho trigger is expected for each average, unlike in external triggering where the trigger is expected only in the beginning and then all averages are measured without triggering.

### **Use Ampl Tacho**

#### **yes, no**

When **yes** is set, then the tacho pulses will be created by amplitude trigger level, not from tacho sensor. Set the channel and level by the same way as for amplitude trigger. Set the **Ampl Tacho Hysteresis** to 30-50% of level to avoid creation of more pulses in near times. It could happen when signal is noisy. Sometimes you need to try more percentage values to find the correct one.

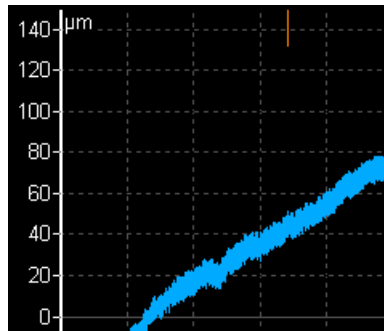
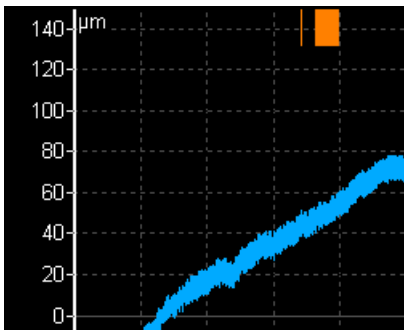

**Ampl Trig Level (unit)**

See the description of the **amplitude** mode (Trigger Source section). The unit is the unit of the sensor on the selected channel (**Ampl Trig Channel**).

**Ampl Trig Channel**

The number of channels, which will be used for **amplitude** triggering.

**Ampl Tacho Hysteresis**

See **Use Ampl Tacho**

**Pretrig (%)**

value in (100, -100) or user

Usually the measurement process (e.g., time signal) begins exactly from the trigger moment. But in some applications, you are also interested in knowing the signal before the trigger. The required time should be defined in seconds, but in signal analyzers it is usually defined as percentage part of the total signal length.

When 1 second time signal is measured and pretrigger=25, then 0,25s will be taken before the trigger and 0,75s after the trigger.

Also, a **negative pretrigger** could be used. It means that the time signal will be taken later then the trigger pulse.

**Sensors**

When you connect the sensors to the instrument, you have to specify what kind of sensors you are using. The Sensors button is displayed on most of the screens and once it is there, it is on the bottom.

Push the **Menu** on the main screen and select **Sensors**. Push the **OK** button. In the next menu select the channel sensor you want to define.

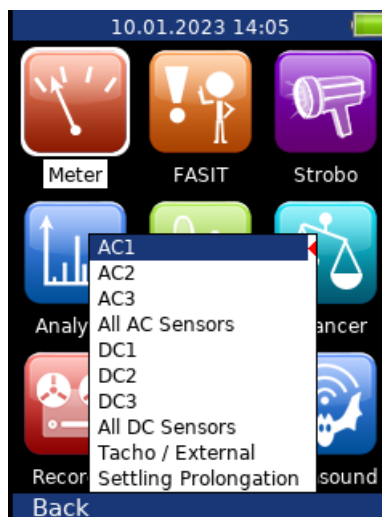

**AC1 – AC3**

setting of each AC channel properties

- All AC Sensors**      setting of all AC channels together
- DC1 – DC3**        setting of each DC channel properties
- All DC sensors**    setting of all DC channels
- Tacho**             setting of tacho channel properties
- Settling Prolongation** if you need longer time for sensor settling, use this item

## AC sensors

AC (alternate current) sensors are used for signals, e.g., vibrations.



### ICP

**on, off**            the selection of required setting accordingly to the sensor type

### Sensitivity[mV/unit]

There are options **1,10,100, user**

### Unit

The unit selected from the list or the user unit

### Name

**undef, user**    You can optionally enter a name of the sensor by choosing **user** item. Use **undef** item to reset the sensor name.

### Saving sensor

Parameters of named sensor can be saved. After you enter the name open the **Name** menu again. New item **save** is available now. When you choose then this item the sensor will be saved.

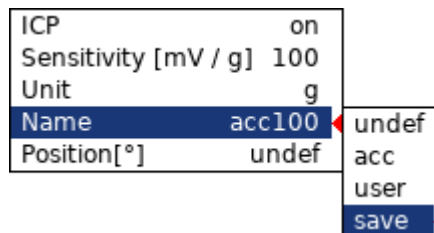

**Note!** If you want to save a sensor with a name which has been already defined, you'll be asked to rewrite its parameters.

Sensor "acc100" has been already defined.  
Rewrite its parameters?

### Loading sensors

Saved sensors are displayed on when you open the **Name** menu item. Select a name of a saved sensor and press OK. Then its parameters are loaded.

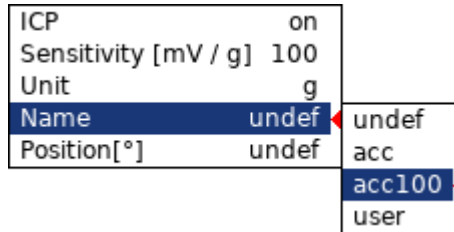

**Note!** If you choose “user” option and then enter a name which has been already saved (e.g., “acc500”) you'll be asked to load its parameters.

Sensor "acc500" has been already defined.  
Load its parameters?

### Deleting sensor

Select a sensor which you want to delete. Open the **Name** menu again. Now new item **delete** appears. Select this item and press OK. The sensor will be removed from the list.

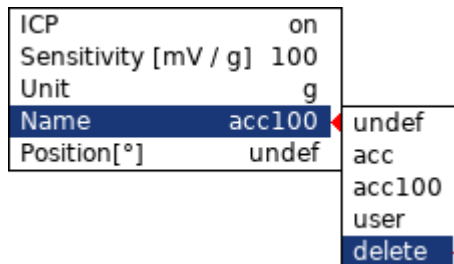

### Sensors list import

Sensors can be saved also in Virtual Unit application (see more about Virtual Unit in VA5 / Virtual Unit manual). In Virtual Unit, the list of saved sensors is available as **data\Sensors\sensors.json** file in Virtual Unit's working directory (by default *C:\ProgramData\Virtual Unit*). You can use this file to transfer your sensors list into instruments. Copy the *sensors.json* file into *va3* directory on VA3 flash drive. Then, after starting the instrument, the file is automatically imported and the sensors list is used in the instrument.

**Position**

The angle of the sensor (see picture below). Usually used for proximity sensors.

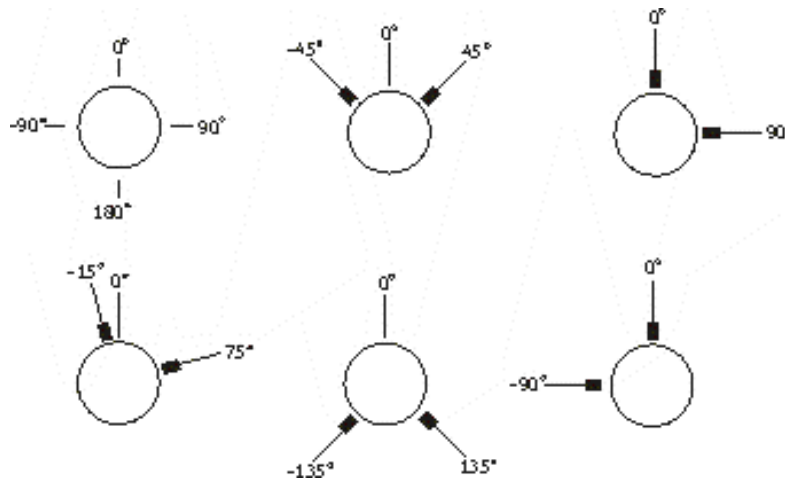

**DC sensors**

DC sensors are used for discrete current signals, e.g., temperature, pressure, etc.



**Sensitivity [mV/unit]**

sensitivity value

**Offset [mV]**

offset value

**Unit**

the unit selected from the list or the user unit

**Name**

the name of sensor (see AC sensors for more details)

## Position

the angle of sensor (see picture above). Usually used for proximity sensors and GAP measurement.

The used formula: **output value in Unit = (input value in mV - Offset) / Sensitivity.**

## Tacho / External

A tacho probe or an external trigger source is connected into the TRIG input. The TRIG input signal should contain pulses which can be used for speed calculation or for measurement triggering.

For better explanation, see picture below:

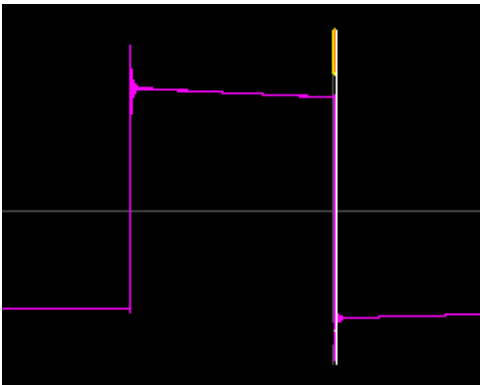

The **magenta** line is tacho signal.

**Grey** line is trigger level.

**Yellow** line is for the created tacho pulse.

You can set tacho in VA3 device in 'Sensors' menu. You can find it in **main menu** (press F2), choose '**Sensors**' and then pick '**Tacho**' option. Once you confirm it you get also more options for tacho settings.



## Tacho Trig Level [V]

The trig pulse is created on this level. This level must be between the minimum and maximum of trig input signal. The signal from tacho generally occurs in two forms. It differs in signal change during reflection from reflective tape. Positive reflection means that the voltage increases during reflection. Negative reflection means that the voltage decreases during reflection.

1. **Positive reflection** example: 0V voltage increases to 5V during reflection.
2. **Negative reflection** example: 5V voltage decreases to 0V during reflection.

The A4300 – VA3 PRO instrument enables work with both types of reflection in -30V to +30V range. That means you can connect almost any kind of tacho sensor. You need to setup the Tacho Trig Level **before measurement**.

We have **three possibilities** how to setup the level.





The **factory** value 6V should work for most of tachometer sensors. However, when the factory value doesn't work, it means that the instrument doesn't recognize tachometer pulses. The speed is not measured. You need to change this value.

Easy way is to use **detect** function for correct value setting.

**Note!** The tachometer sensor must be connected and machine must be running, when you select the detect function.

A **Detecting level** window appears during detection.



The min, max of signal and also the new trig level value will be displayed after detection.



The instrument doesn't remember the 'min' and 'max' values. These values will not be displayed again after you close and reopen the tachometer menu.

If the **Signal swing is too small** message is displayed. It means that the changes of tachometer signal are too small for tachometer pulse creation.

You can enter other value manually by selecting the **user** item. But to estimate functional value is not so simple. The value you need to enter is not a value directly from the sensor but after a signal processing in the tachometer input, where a DC component of the tachometer signal is removed and the signal is transformed to 0 - 10V range. The advice is to try 5V, 4.5, 5.5, 4.0, 6.0 3.5, 6.5 etc. so long until the triggering starts to work.

### Trig Edge

**rising, falling**

Edge for triggering.

**Note!** The trig level together with the trig edge define the time of trigger (the time when the trig or tachometer mark is generated).

If the edge is set to **falling**, then the time of trigger comes when the TRIG signal **decreases** from the value higher than trig level to the value lower than trig level.

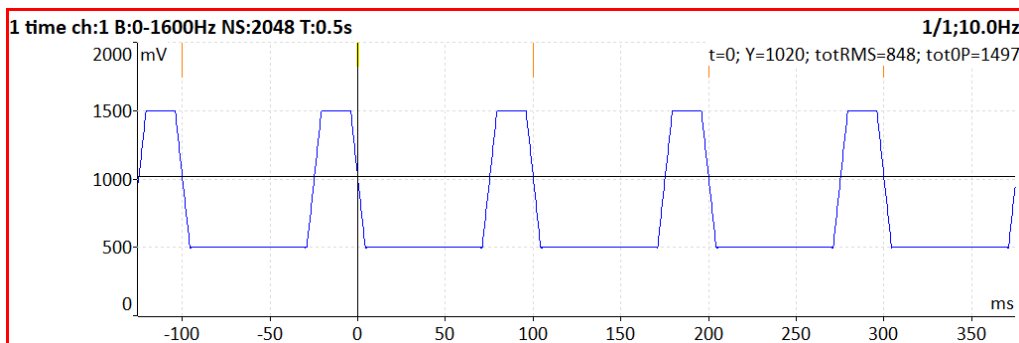

If the edge is set to **rising**, then the time of trigger comes when the TRIG signal **increases** from the value lower than trig level to the value higher than trig level.

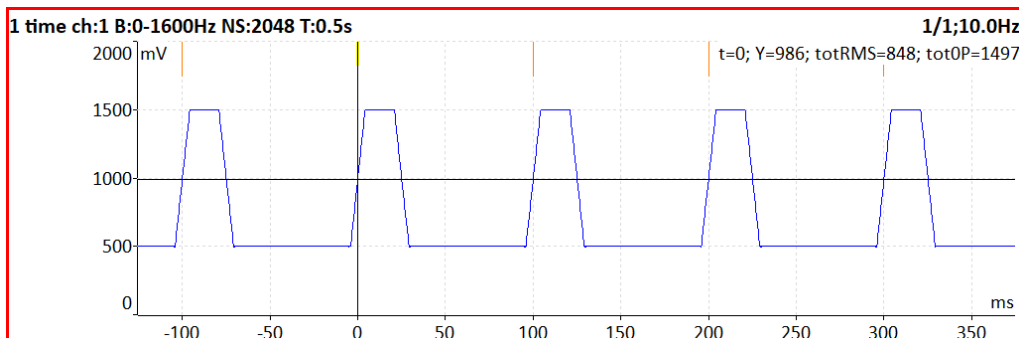

### **Pulses per rotation**

This value has to be set for correct speed evaluation, when more pulses are generated during one rotation. If *Pulses per rotation* does not equal one, *Trigger Source* cannot be set to tacho. Then, the tacho signal is used for speed calculation, but cannot be used for triggering.

### **Min Speed**

It is the lowest speed, which the user is interested to measure with tacho. We suppose that there is one puls per one revolution. In other words, it means how long the instrument will wait for two tacho pulses (the speed is calculated from the time between two pulses). When the pulses are missing, then the NO SPEED error is displayed. When you choose 1Hz, then the waiting interval is 1 second. When you enter 0.1Hz, then you will wait 10 seconds. You should be aware of time prolongation of each measurement.

If the machine's speed is lower than **Min Speed**, then tacho trigger will not be used.

**Attention!** If the shaft speed is lower than *Min Speed*, no tacho marks are generated and no tacho trigger can occur.

**Attention!** By decreasing the value of *Min Speed*, you increase the time needed for tacho probe failure recognition.

### **Global**

The parameters which have effect on all functions (or many functions) are understood as *Global parameters*. Press the **Menu** on the main screen and select **Global**. Press the **OK** button. You get this window with default settings.

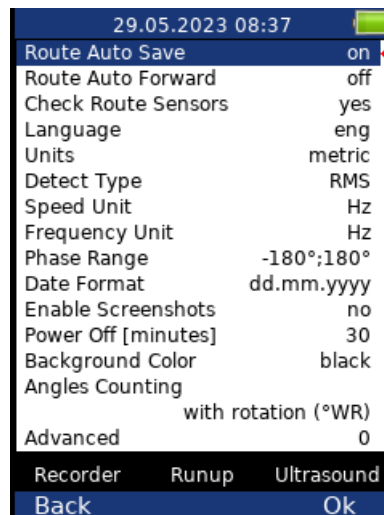

### **Route Auto Save**

**on, off** automatically saves the data after reading is taken (in route module)

### **Route Auto Forward**

**off, on**

The list of measurement points is automatically displayed after data saving and next measurement point is selected. The necessary condition is, that all measurements from last point are taken and correctly saved.

### **Check Route Sensors**

**yes, no**

Each point in the route contains the sensor setting, which is defined in DDS. The instrument contains also the sensors setting (**Sensors** button). Both settings are compared for each point during the route readings. When the sensor setting in point is not equal the sensor setting in instrument, then the **Used sensor** window appears. It is the warning to the user.



Used Sensor  
on AC1: 100 mV / g; ICP on

The user should connect the correct sensor to the unit with the parameters displayed in window. Confirm by pressing **Ok**. The setting in **Sensors** will be rewritten by point setting in route. You can make changes in setting now using the **Sensors** button.

The sensor can have defined a name (e.g.ACC100). It should help the user in field to use correct sensor. These names are checked in instrument. When the names are not the same, then the **Used Sensor** window appears. No checking of other parameters is done.

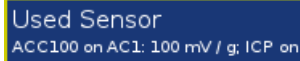

Used Sensor  
ACC100 on AC1: 100 mV / g; ICP on

### ***Language***

ENG, CZE, ...

### ***Units***

metric, imperial

### ***Detect Type***

**RMS, 0-P, P-P**

Default detect type for spectral amplitude values. E.g. spectral graph in analyzer module uses this type of amplitude but you can enter another value for particular graph in its **Graph Properties** menu.

### ***Speed unit***

Hz, RPM, CPS, CPM

### ***Frequency unit***

Hz, RPM, CPS, CPM

### ***Phase Range***

-180,180

0, 360

### ***Date Format***

yyyy/mm/dd

dd.mm.yy

mm/dd/yyyy

### ***Enable screenshots***

**yes, no**

The screenshot menu items will appear in menus

### ***Power off [minutes]***

Time period for switching off

### Background Color

**black/white**

Background color of graphs

### Angles Counting

**with rotation (°WR), against rotation (°AR)**

You can define the direction of angles (phases). The selected choice is then signed behind degree mark as WR (with rotation) or AR (against rotation).

**Note!** Although almost all degree symbols in the application are labeled with WR or AR mark you won't see this in the manual because many of the screenshots were taken before Angles Counting was implemented.

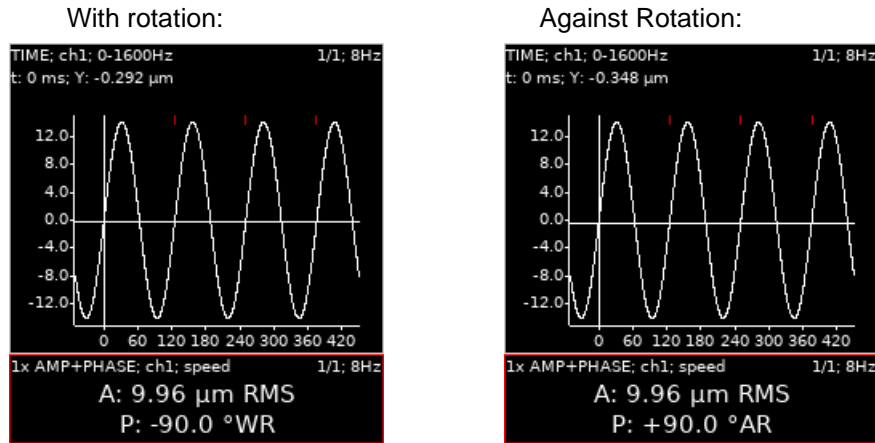

On the pictures above, you can see the time waveform with tacho marks. The tacho mark comes 90° before the maximum of the signal in the direction of rotation. If we choose the **with rotation**, then we say the tacho mark is 90° before the signal maximum and thus the angle (phase) is **-90°**.

In case of **against rotation**, we say the signal maximum is 90° behind the tacho and the angle is **+90°**.

The main use of this parameter is in balancing. Some users are used to count angles with rotation and other users want to count against rotation. The VA3 enables to set your required direction.

**Warning!** By changing this value, all angles (phases) become opposite. Therefore, do not change it between readings if you want compare phases.

### Advanced

The value of **Advanced** contains several various parameters itself. Every of them has only two available values **ON** and **OFF**. It is the same as the DIP switch in electronics.

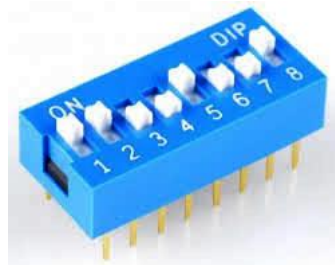

Each individual switch is like the bit in computers. The bit also can have only two values, 1 (ON) and 0 (OFF). If we have eight bits (switches) then we can write them as the series of 0 and 1.

**1 0 0 1 0 1 0 0**

If we are talking about eight bits, then we call it the byte. Computers use it in the same way.

People use the decimal system for counting. For example if have the number 8567, we look at this number as

$$8567 = 8 \times 1000 + 5 \times 100 + 6 \times 10 + 7 \times 1$$

We can express it in better math formula

$$8567 = 8 \times 10^3 + 5 \times 10^2 + 6 \times 10^1 + 7 \times 10^0$$

The number 10 is the base of decimal system. But also other values can be used for that. The computer uses number 2 and the binary system. It has the advantage, because every bit has only two possible values 0 and 1. In decimal system each bit should have to have 10 values.

If we use 8 bits in binary system, then value of byte (all 8 bits) is

$$b_1 \times 2^0 + b_2 \times 2^1 + b_3 \times 2^2 + b_4 \times 2^3 + b_5 \times 2^4 + b_6 \times 2^5 + b_7 \times 2^6 + b_8 \times 2^7$$

If we express it with decimal numbers, then it is

$$b_1 \times 1 + b_2 \times 2 + b_3 \times 4 + b_4 \times 8 + b_5 \times 16 + b_6 \times 32 + b_7 \times 64 + b_8 \times 128$$

If all bits are equal 0, then result is equal 0. If all bits are equal 1, then result is equal 255.

The calculation for 8 bits ( any combination of 0 and 1) we can write in next form

|   |   |   |   |    |    |    |     |
|---|---|---|---|----|----|----|-----|
| 1 | 0 | 0 | 1 | 0  | 1  | 0  | 0   |
| x | x | x | x | x  | x  | x  | x   |
| 1 | 2 | 4 | 8 | 16 | 32 | 64 | 128 |
| " | " | " | " | "  | "  | "  | "   |

$$1 + 0 + 0 + 8 + 0 + 32 + 0 + 0 = 41.$$

The result value 41 is expressed as one number and contains uniquely information about values off all bits.

### Bit description

The instrument does not use all 8 bits yet.

**b1** Do not display the window with question "Save data?"

The default value is 0. When you close the set of measurements or before the new measurement, the instrument asks you **Save data?**. Many users save data when they need it and this warning question is useless. If you set the B1 to 1, then this question will not be used.

**b2** To cancel the measurement of point after the entering of manual values

The manually entered values are required before the measurements with sensor. If the b2=1, the new window appers after manual values entering. It asks **Continue measuring?** and you can or cannot continue to measure with sensor. Default state is b2=0 and the measurement with sensor is always done.

### Date and time

Define date and time.



**Note!** Sometimes, the clock battery inside the instrument can discharge when you don't use the instrument for a long time. In this case, the clock is reset to the initial value and you will be prompted to set date and time after instrument startup.

Enter date and time

## Update

The list of update files appears (files, which were saved to VA3). Select required version and press OK (F3).



## How to update the firmware

Download the latest firmware from [www.adash.com / Downloads / Adash software / A4300-VA3 Pro](http://www.adash.com/Downloads/Adash%20software/A4300-VA3%20Pro)

Firmware update instructions:

- Download the firmware (e.g., A4300\_ver0108.up) from above website and save it to your computer.
- Connect the VA3 Pro instrument to the computer via USB cable.
- Copy the firmware from the computer to the VA3\_DISC /va3/ updates.  
(Newer devices appears on PC as e.g., VA3\_626754. Depends on the serial number of the device.)
- Use Safely remove hardware function and disconnect the instrument from the computer.
- Switch-on the instrument and press Menu on the main screen.
- Select the Update item and press OK.
- Select the required firmware file from the list (more version files can be saved in the instrument). Press OK.
- The list of commands appears.
- The instrument is switched off.
- Switch the instrument on again.

## Export Logs

It is the tool for firmware development. You can create the log file, which is saved in **VA3\_DISC/va3/logs**.



## Screenshot

Only if enabled on Global. The screenshot image will be saved to disc - **VA3\_DISC/va3/screenshots**.



## **Update of the new measurement module(s)**

Once you will purchase additional measurement module you will receive unique license file according to the serial number of your VA3 Pro instrument. The license file contains the information which measurement modules are included in particular VA3 Pro instrument.

License update instructions:

- VA3 Pro instrument has to be switched off. Connect it with PC via USB cable.
- Copy the license file (license file has **.a43** extension) into **VA3\_DISC** to **va3** folder.  
(Newer devices appears on PC as e.g. VA3\_626754. Depends on the serial number of the device.)
- Disconnect the VA3 Pro from PC (always use safely remove feature to avoid failure).
- Switch on the device.



## Info

If you press **Info** (F1) on the main screen, the system information will be displayed.



## Speed detection

You need to know the speed of the measured machine in some cases. We will describe in this chapter how speed detection works.

Speed detection is done before the measurement itself. All you need to do is to press the Start button. During the speed detection there is an informative note displayed in the right top corner.

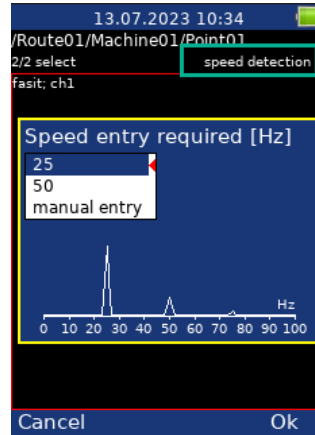

If the tacho probe is detected – no other speed detection starts. The speed is measured automatically by tacho probe.

The highest peaks are found and displayed in the list (see screenshot below). The highest amplitude is on the top of the list. The spectrum is displayed also. Select the correct value and press OK.

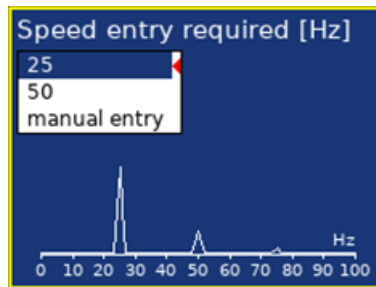

If you want to leave the speed undefined, then select unknown speed.

If no value in the list is correct, then select manual entry and enter the speed manually.

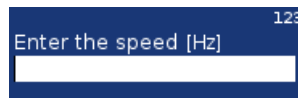

The speed detection is available only when vibration sensor is used for point reading. In other cases, the warning appears. Then the manual entry of speed is required.

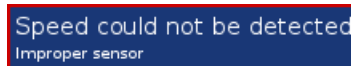

If the measurement for speed detection fails, then error message appears. E.g., ICP error.

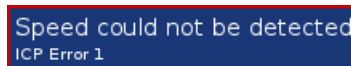

If the speed value is detected, it is automatically saved to the data header for following measurement in the same way as the speed value measured by tacho probe. If the speed is measured by tacho probe simultaneously, the value from the tacho probe has priority when saving.

## Meter

It enables to perform basic measurements for vibration diagnostics.

### Settings

Press the **Menu (F2)** button and select the **Meter Settings**.

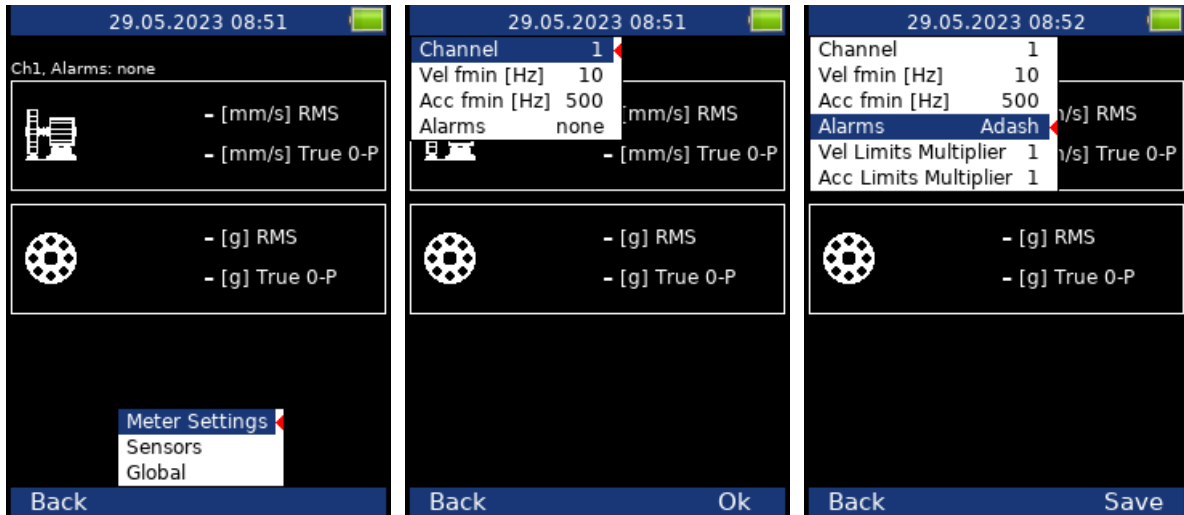

#### **Channel**

Number of the input channel. The channel can be switched also outside the settings dialog using up and down arrows.

#### **Vel fmin [Hz]**

By default, the velocity measurement is taken in 10 – 1000 Hz range to detect the overall machine condition. This range is not convenient for low-speed machines (below 10 Hz = 600 RPM). Therefore, you can setup lower value of fmin.

#### **Acc fmin [Hz]**

By default, the acceleration measurement is taken in 500 – 25600 Hz range to detect bearing faults. Using the *Acc fmin* you can change the minimum frequency of the filter. E.g., in some cases, there may be vibrations above 500 Hz which are not caused by bearing faults and you know it. Then, you can set the *Acc fmin* value to 5000 Hz to filter these vibrations out.

#### **Alarms**

Settings of standards which define the limit values for warning (yellow color) and danger (red color); see Appendix B: Standards for vibration measurements. When any alarms selected the measured values on first screen are displayed in traffic light colors.

**adash:** Adash\_Limit\_Values, Speed\_detection needed.

**R13, F13, R24, F24:** ISO\_10816\_limit\_values according to ISO 10-816, R means rigid, F means flexible, the number means machine group according to ISO 10816 standard.

**none:** no traffic-light colors used

Additional options are available when Alarms are set as **adash**:

#### **Vel Limits Multiplier**

The Adash factory Machine\_Limits may be too much or too little for some machines. Therefore, for velocity measurements, you can adjust them using the *Vel Limits Multiplier*. Values greater than one increase the limits

values (thus the alarm is less strict) and values less than one decrease them (alarm is stricter). A value of one means the limit remains as shown in the machine limits graph.

### ***Acc Limits Multiplier***

Same as Vel Limits Multiplier but used for Adash Bearing\_Limits.

**Note!** The Meter Settings are connected with the FASIT\_Settings. Thus, the values of parameters set in this menu are also used in the FASIT module. One exception is the Alarms parameter, which is not used in the FASIT settings because FASIT only uses Adash alarms.

### ***Sensors settings***

In the **Sensors** menu set up parameters for all channels you want to measure. All channels (which have defined vibration sensor) are measured together. Switch displayed channel by pressing up or down arrow.

You need to use the accelerometer to display all possible measurements. If you use a velocity sensor, the acceleration values will not be measured. If you use a proximity sensor, the acceleration values and velocity values will not be measured.

### ***Unit settings***

Displayed units in VA3 device can be set under **Global** item. Set up the unit of speed (Hz, RPM, CPS, CPM) in the Speed Unit item. The vibration values are displayed according to the setting of **Units** (metric, imperial). The temperature can be displayed in degrees of Celsius or Fahrenheit.

The units used are set up in **Global/Units** as follows:

#### ***metric:***

acceleration - g  
velocity - mm/s  
displacement -  $\mu\text{m}$

#### ***imperial:***

acceleration - g,  
velocity – in/s  
displacement – mil

### ***Measurement***

Press **Start** button to initiate the measurement. Speed detection runs first (more details in chapter **Speed detection**).

### ***Status bar***

There is a Status bar at the top part of the display. It provides information about the settings and status of the measurement. If the measurement is running there is a red icon labeled **meas** flashing in the top right corner.



**Ch1:** The number of the channel being shown

**1140 RPM Auto:** The value and unit of speed and the method of speed detection:

**Auto:** the speed is detected from the frequency spectrum,

**Manual:** the speed is entered manually by the user,

**Tacho:** the speed is detected by the tacho.

**Alarms:** The standards used for stating the limit values.

### Measurement screens

You can switch between the measurement screens with the left and right arrow buttons.

#### Overall (RMS) and Peak (0-P) values

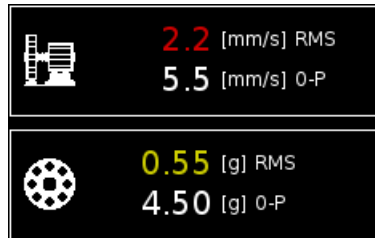

Measurement of Overall and Peak value in the following frequency bands can be seen in the picture above:

**Velocity:** 10 Hz - 1000 Hz

**Acceleration:** 0.5 kHz – 25.6 kHz

The color describing the condition of the machine (green, yellow, red) is determined according to the speed value and vibration value (RMS, Peak).

#### Spectrum up to 200Hz – mechanical looseness detection

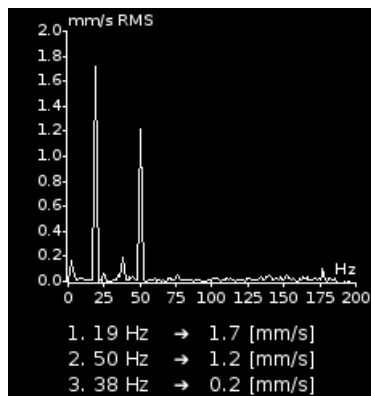

**FFT analysis** of vibrations in the range 2 Hz - 200 Hz in mm/s RMS.

The **3 maximum peaks** found are displayed.

The peaks are arranged according to the vibration amplitude.

#### Time signal for roller bearing diagnosis

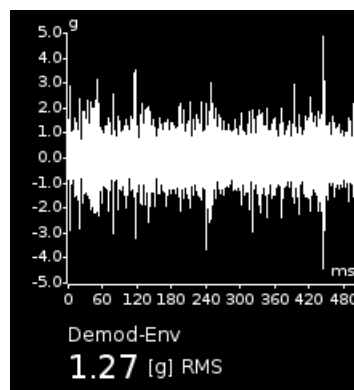

Measurement of time signal and vibrations in the range: 0.5 kHz – 25.6 kHz in g.

The screen shows the actual measured time signal and the Demod - g<sub>ENV</sub> value.

### Vibration in frequency ranges - gearboxes/ bearings

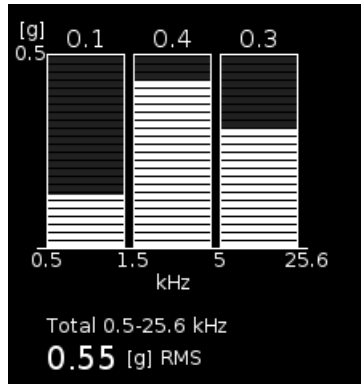

Measurement of RMS vibration values in the ranges:

0.5 kHz – 1.5 kHz in g,

1.5 kHz – 5 kHz in g,

5 kHz – 25.6 kHz in g.

It also displays the Overall RMS [g] value in the range 0.5 kHz – 25.6 kHz

### Displacement values

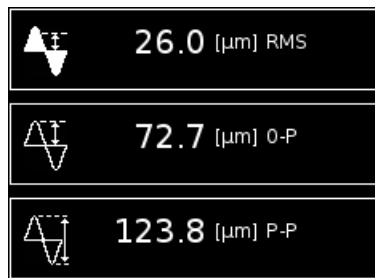

The values of displacement in the range 2-100 Hz are displayed.

### Temperature

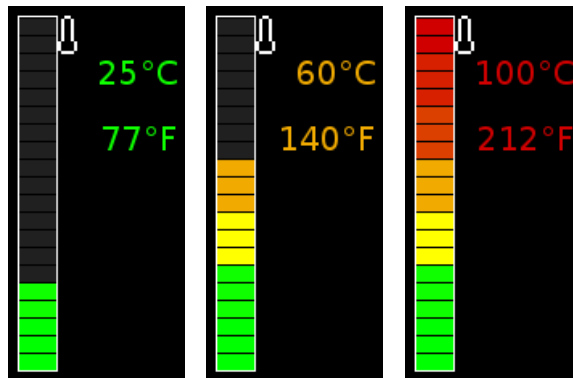

The measured temperature is displayed in degrees Celsius and degrees Fahrenheit. The values are colored according to the measured temperature.

**The ranges of colors are as follows:** less than 30°C - green, 30-45°C - yellow, 45-60°C - orange, 60-75°C – red, more than 75°C – dark red.

# FASIT

The FASIT means the **FA**ult **S**ource **I**dentification **T**ool. This module should help beginners to determine the machine condition and bearing faults.

## Settings

Press **Menu** and select **FASIT Settings**. You will set following parameters:

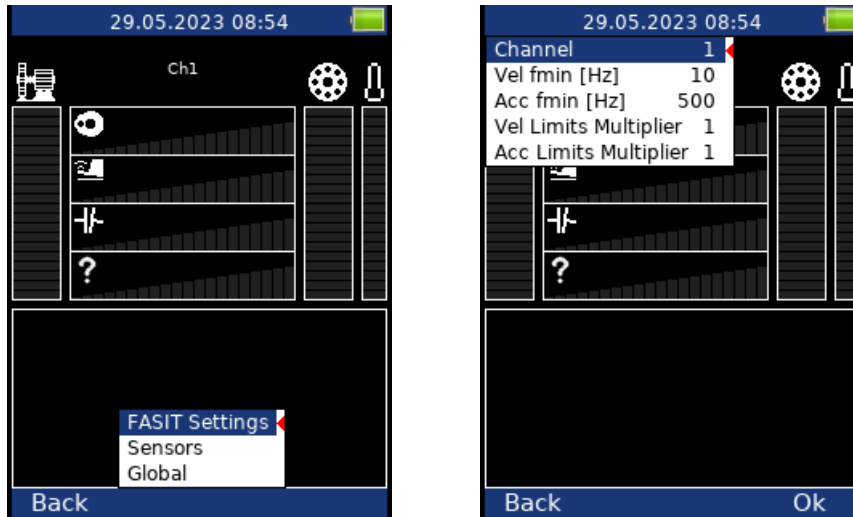

**Note!** The FASIT Settings are connected with the Meter Settings. Thus, the values of all parameters in this menu are remembered when you switch to the Meter module and select Alarms = Adash.

### Channel

The number of the input channel. The channel can be switched also outside the settings dialog using up and down arrows.

### Vel fmin [Hz]

By default, the velocity measurement is taken in 10 – 1000 Hz range to detect the overall machine condition. This range is not convenient for low-speed machines (below 10 Hz = 600 RPM). Therefore, you can setup lower value of fmin.

### Acc fmin [Hz]

By default, the acceleration measurement is taken in 500 – 25600 Hz range to detect bearing faults. Using the *Acc fmin* you can change the minimum frequency of the filter. E.g., in some cases, there may be vibrations above 500 Hz which are not caused by bearing faults and you know it. Then, you can set the *Acc fmin* value to 5000 Hz to filter these vibrations out.

### Vel Limits Multiplier

FASIT uses Adash Limit Values, according to which alarms are displayed. The factory Adash Machine Limits may be too or too little strict for some machines. Therefore, for velocity measurements, you can adjust them using the *Vel Limits Multiplier*. Values greater than one increase the limits values and values less than one decrease them. A value of one means the limit remains as shown in the machine limits graph. On following figures, you can see the effect of the multiplier. The first machine condition bar shows an alarm when the multiplier is set to 1. The second bar shows the same measurement, however the multiplier is set to 2, which means the limit value is twice as high as before. This means that FASIT is less strict and the alarm level is twice lower. The third case shows the situation with the multiplier set to 0.5.



**Acc Limits Multiplier**

Same as Vel Limits Multiplier but used for Bearing Limits.

**Sensors Settings**

In the **Sensors** menu set up parameters for all channels you want to measure. All channels which have defined vibration sensor are measured together. Switch displayed channel by pressing up or down arrow. FASIT uses the measurement of acceleration or velocity from one channel. If you will use a velocity sensor, the bearing condition is not detected. For bearing condition detection the acceleration measurement is necessary.

**Units**

The displayed units can be set up under the Global item. Set up the unit of speed (Hz, RPM, CPS, CPM) in the Speed Unit item. The vibration values are displayed according to the setting of Units (metric, imperial). The units used are set up in **Global/Units** as follows:

**Metric:**

acceleration - g  
velocity - mm/s

**Imperial:**

acceleration - g,  
velocity – in/s

**Measurement**

Press **Start** to initiate the measurement. The speed detection runs first (see chapter **Speed Detection**).

**FASIT screen**

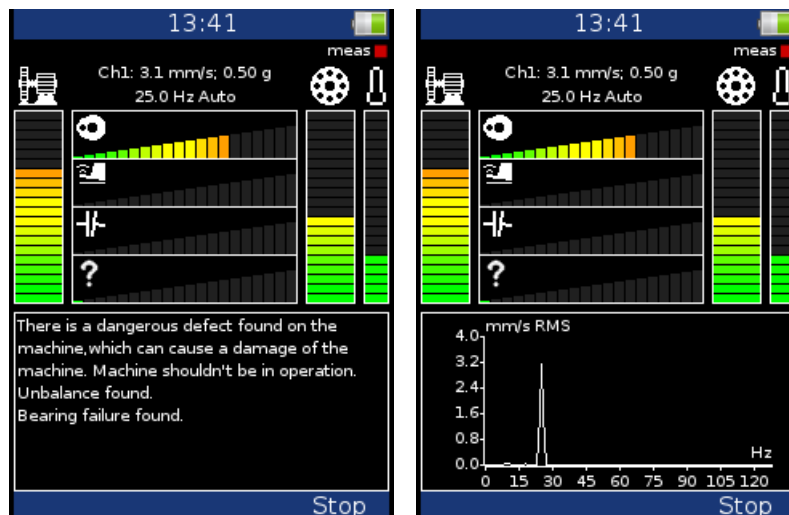

The running measurement is indicated by a flashing red icon labeled **meas** in the top right corner.

Information about the measurement status and settings is displayed at the top of the screen: the number of the input channel shown, the overall RMS velocity and acceleration value, the speed value and the method of speed detection.

- Auto:** the speed is detected from the frequency spectrum,
- Manual:** the speed is entered manually by user,
- Tacho:** the speed is detected by the tacho.



FASIT displays several graphs and the traffic light colors are used. Two main graphs show overall machine condition (left vertical bar) and bearing condition (right vertical bar). Next to the bearing condition bar there is a bar showing the temperature measurement. The range of the temperature bar is 100°C (212°F).

The bars show the severity of the following faults:



Overall machine condition, see *Appendix C: Standards for vibration measurements*



Overall bearing condition, see *Appendix C: Standards for vibration measurements*



Severity of unbalance fault



Severity of mechanical looseness



Severity of misalignment



The severity level of a different type of a fault.

The text message (e.g., machine is in good condition) or the graph of the velocity spectrum is displayed at the bottom part of the screen. To switch between them press the Shift button or left/right arrow button.

## **Strobo**

You can use the instrument as a stroboscope in this module. White LEDs on the top panel start to flash regularly with the frequency set up on the screen. When we have to study or to visually inspect machinery which has cyclically moving parts, then the stroboscope enables us to visually slow down or freeze this movement (rotation, cyclic movement, oscillation and vibrations).

Imagine a rotating disc with one hole. When the flashes of light are synchronized with the disc rotation speed, then there is just one flash made during one rotation. It means that the disc is lit up when the hole is always in the same position. It is the principle of the illusion of frozen movement.



Press the **Menu** and select **Strobo Settings**. Define whether the tachometer will be used or the user will select the frequency.

If the user frequency is selected then:

- use the right/left arrow for changing the frequency in Hz,
- use the up/down arrow for changing the frequency in RPM.
- use the F1/F2 button for divide/multiply frequency by 2.

### ***Easy access***

The **Strobo** module could be ran from anywhere. You don't need to be on the main screen. Turn the light on (press key **7**). When the light is on, press button **3**. The **Strobo** module opens.

**Warning!** The Strobo cannot be opened during measurement.

# Analyzer

The **Analyzer** module is the basic module for signal analysis. If you have not prepared the **Route** measurement, then you use the **Analyzer** for analysis. All required parameters must be set by hand or you can use the saved measurement parameters from memory.

## **Basic concepts**

### **Meas**

The *Meas* means one measurement as it is usually understood, for example overall value or time signal or spectrum or other.

### **Graph**

The graphical form of that *Meas* values displayed on the screen we will call the *Graph*. One Graph works with data from one *Meas* item. You should keep in mind that also one overall value is the *Graph*.

### **Set**

The *Set* is the most important term in the Analyzer module. The *Set* is the set (or group) of one or more *Meas* items, which the user wants to collect and display together. For example, you want to take 4 *Meas* together - acceleration overall, velocity overall, velocity time signal and velocity spectrum. You prepare the *Set*, which includes these 4 required *Meas* items. The definition of *Set* is saved in the Analyzer memory. You can save many various *Sets*, which can contain your often used sets of measurement. Then you select one *Set* and run it. The taking off all measurements included in the set is made simultaneously.

### **Reading**

The Reading means all *Meas* items (signals and values) from one set measured together at the same time.

## **Analyzer menu**

The first Analyzer screen contains the list of *Sets* saved in the memory (in the picture, BASE1, BASE2, BASE3) or the empty list, when no *Sets* were created.

The main analyzer menu enables to handle with sets.

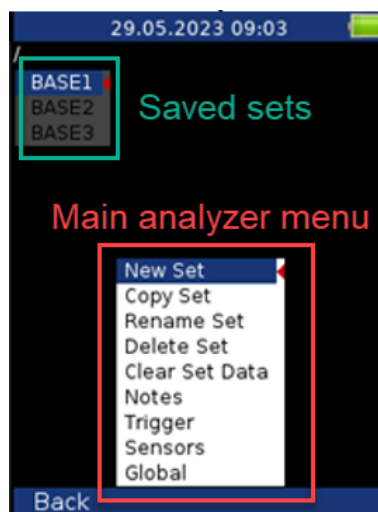

### **New Set**

Select the New Set and press OK. Enter the name and confirm by pressing OK. Use the Shift (F1) to change the keyboard function (abc, ABC, 123, <->). The last choice <-> enables to move in text by arrows and to delete

characters (buttons 7 and 9). Press the Cancel button to cancel the New Set procedure (when the option <-> is on, otherwise the Cancel button is not available). When you do not enter the name of set and press OK, the procedure is cancelled as well.

### **Copy Set**

Option which enables to copy the actual set to the new one.

### **Rename Set**

Option which enables to rename the actual set.

### **Delete Set**

Option which enables to delete the whole set.

### **Clear Set Data**

Option which enables to delete all readings saved in the set.

### **Notes**

See the Route chapter for details

## **New Meas (Basic, Advanced)**

You need to choose one of the sets in the main analyzer screen (as described in section above) and confirm it with OK. Afterwards you add measurements for particular set.

Press the menu button **F2** and you get measurement menu.

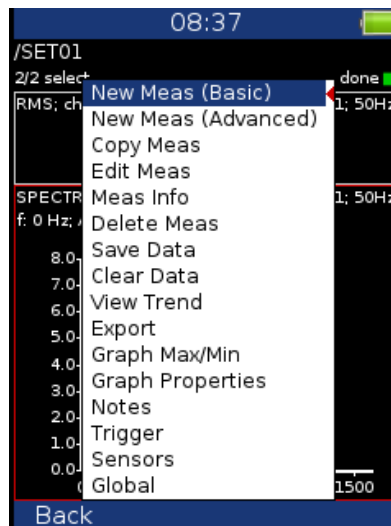

You have two options here. You can choose basic or advanced new measurement.

### **New Meas (Basic)**

It includes list of predefined templates. You can select one of them (see picture below).

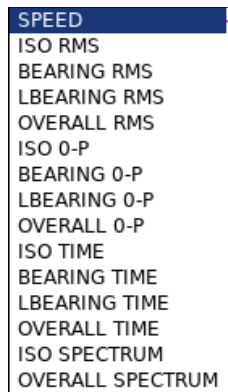

**Note!** You can modify the basic measurements list in *Virtual Unit* application (see more about Virtual Unit in VA5 / Virtual Unit manual). The modified list can be transferred into VA3 if you copy the *meas\_template* file from the *data\VA4template* directory in Virtual Unit's working directory (by default *C:\ProgramData\Virtual Unit*) into *va3* directory on VA3 flash drive. Then, after starting the instrument, the file is automatically imported and the modified basic measurement list is applied. If you want to reset the basic measurement list into factory state, just place an empty *meas\_templates* file into the same location. Then after starting the instrument, the basic measurements list will be restored.

### ***New Meas (Advanced)***

When you choose this option you get menu to define measurement parameters. The content of menu changes based on the measurement – **Type** selection (first row). Next parameters are described below.:

#### ***Channel***

Channel number where measurement is done (1, 2, 3)

#### ***Unit***

The selection of required unit to be displayed.

#### ***Detect type***

Detected value property (P is peak). Each detect type is described below.

**Scaled 0-P:** it is equal to  $1,414 * RMS$ .

**True 0-P:** it is true zero-peak value in the waveform (the highest value captured in time signal).

**Scaled P-P:** it is equal  $2.828 * RMS$ .

**True P-P:** it is true peak-peak value in the waveform (the difference between highest positive and highest negative value in signal).

**AVG:** it is average value of all samples (total sum of absolute values divided by number of samples).

**Crest:** it is equal True 0-P/ RMS.

**Kurtosis:** standard statistical formula for Kurtosis.

#### ***Fmin [Hz]***

The low cut-off frequency of band pass filter, which is applied to the signal before further processing (evaluation). The **none** value (available only when no integration is applied) means, that only input DSP filter is applied (approximately 0.6 Hz). See the frequency characteristic of codec highpass filter on the picture below.

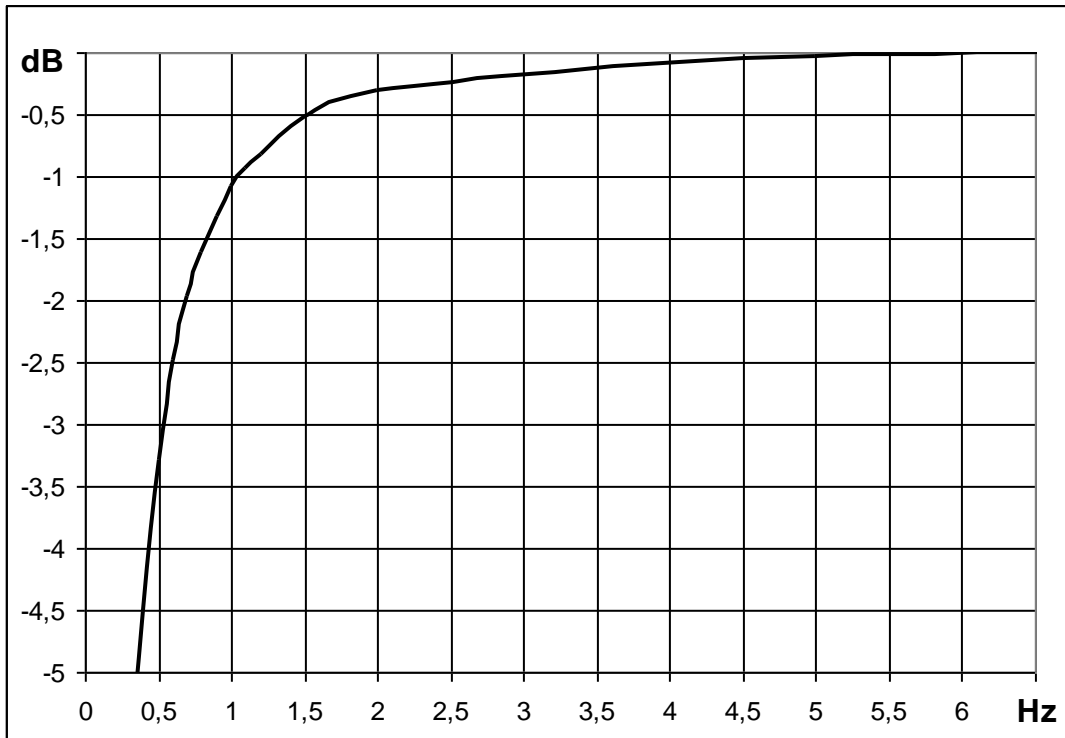

**Fmax [Hz]**

It is the high cut-off frequency of band pass filter, which is applied to the signal before evaluation (removes high frequencies). Fmax may be used to calculate **sampling frequency** which is the next item in the menu (see *Fsampling*).

**Warning!** Maximum value of Fmax = 90 kHz (Fsampling = 196608 Hz) is available only for one channel.

**Fsampling [Hz]**

By default, the sampling frequency is determined from the Fmax as the lowest possible frequency from the frequencies row so as the sampling theorem is satisfied.

$$fs > 2 * fmax$$

Sampling frequency can be only one of these values:

**64, 128, 256, 512, 1024, 2048, 4096, 8192, 16384, 32768, 65536, 196608 Hz**

Each value is power of two, except the last one. The highest value should be used in special cases where you need the highest possible frequency range. However, keep in mind the fast frequency is not power of two and as a consequence you will not get nice values for spectrum resolution or time waveform length because the input signal length is always power of two.

The **by fmax** value of *Fsampling* parameter satisfies the sampling theorem and it is the lowest possible sampling frequency calculated from *Fmax*.

However, when you need to use a certain filter, the suggested sampling frequency may not be sufficient. Look at the sine wave with a frequency of 80 Hz. You may set *Fmax* as 100 Hz which is suitable lowpass frequency for your signal. If you leave the sampling frequency determined by *fmax* then its value is estimated as 256 Hz. This means your signal will be sampled with  $256 / 80 = 3.2$  samples per period.

Fmin [Hz] 10  
 Fmax [Hz] 100  
 Fsampling [Hz] 256  
 by fmax

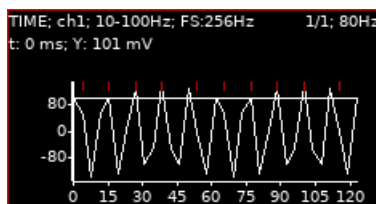

As you can see on the picture, it's hardly recognizable that it is a sine signal. It would be better if you use higher sampling frequency. And if you still need to use the band filter with 100 Hz fmax frequency, then the *Fsampling* parameter enables you to define any higher sampling frequency from the frequencies row and use co called oversampling. With oversampling, the signal is rendered more precisely.

Fmin [Hz] 10  
 Fmax [Hz] 100  
 Fsampling [Hz] 2048  
 oversampling: 8x

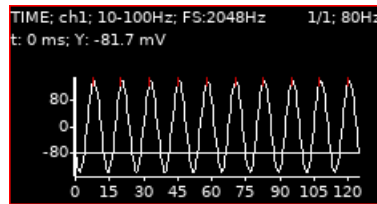

Oversampling is also useful when using filters in orbits. Compare same orbit with various sampling frequency.



### **DEMOD fmin [Hz]**

The low cut-off frequency of band pass filter, which is applied to the signal (removing low frequencies). It is parameter in measurements types g-demod.

### **DEMOD fmax [Hz]**

The high cut-off frequency of band pass filter, which is applied to the signal (removing high frequencies). It is parameter in measurements types g-demod.

*The DEMOD fmax is used to determine a sampling frequency.*

### **ACMT FS [Hz]**

The sampling frequency for ACMT evaluation. See the ACMT chapter for better understanding. It is parameter in ACMT measurement type.

### **Samples**

Number of samples (Speed control = off). The correspondent signal time length (**t**) is displayed under this item.

### **Lines**

Number of lines. The correspondent signal time length is displayed under this item.

### **Orders**

(1/2,1-5), (1-5), (1/2,1-10), (1-10)

### **Averaging**

**for spectrum:** linear, peak hold, time synchro

**for static values:** linear, maximum, minimum, median

**Note!** Averaging is used to remove variability in time signal and give us information only about values we are interested in. It can be used to filter e.g., noise from the signal we want to analyze further. Noise values are random in the time signal – with averaging these values are basically “inhibited”.

**Peak hold averaging** – it holds the peak value – it can be used to track the minimum and maximum amplitudes in a spectrum over time.

**Time synchro averaging** works like this: the time signals are averaged (must be controlled by tacho in most cases) and from averaged time waveform is calculated the final spectrum. It can be set for non-enveloped and non-zoomed spectra.

## Avg

averaging number

How the averaging is used depends on the type of trigger:

|                          |   |
|--------------------------|---|
| <b>freerun</b>           | when the measurement is started, the signal needed for averaging is taken continuously                                  |
| <b>external</b>          | when the external trigger comes, the signal needed for averaging is taken continuously without waiting for next trigger |
| <b>tacho</b>             | every signal for averaging is triggered (constant phase)  |
| <b>amplitude</b>         | every signal for averaging is triggered (constant phase)  |
| <b>manual</b>            | first signal for averaging is triggered manually, next signals are taken freerun  |
| <b>manual sequential</b> | every signal for averaging is triggered (constant phase)  |

**Note!** If averaging is used, you probably want the measurement to be finished with the number of averaged values as defined. Sometimes, it is not possible to stop the measurement right when the averaging has been finished. Therefore, when you press the *Stop* button during a measurement with uncompleted averaging, the measurement process will not stop immediately. Instead, a **Finishing Averaging** info will appear in status bar. You may wait until the averaging is finished or push the *Stop* button again to stop the measurement process regardless the averaging is finished or not.

finishing averaging ■

If trigger is set to manual sequential and you press the *Stop* button, then the info flashes between **Finishing Averaging** and **Wait Trig** until you trigger the next measurement or stop the measurement process completely.

## Overlap [%]

Overlapping of signals in averaging.

**Note!** Overlapping is used to speed-up the averaging. When overlap is used, part of the signal remains and part of it is overlapped with the next one. It means, when we set overlap to 50% and we have time signal with length 1s (two averages – two signals and each of them is 1s long), the final signal will be 1,5s long (not 2s, half of the signal is overlapped as we set this value to 50%).

## Sampling ????

**standard:** enables the amp+phase measurement up to 2500 Hz (150000 RPM)

**fast:** enables the amp+phase measurement up to 5000 Hz (300000 RPM). Low speed limit is higher with the fast sampling.

**Warning!** It is recommended to use the fast sampling only when it is needed because the processing is more complicated.

**Warning!** Fast sampling is available only for one channel measurements.

## Resolution

**speed / value**

This number defines the bandwidth of the spectrum line. When two near frequencies exist and they are contained in one spectrum line, then this line shows the sum of both. When we want to get correct amplitude and phase value for example on speed frequency, then we must ensure that the spectrum speed line bandwidth contains just the speed frequency. If other frequency exists in the speed line, then it makes disturbing and we get wrong value. The next important feature of the **speed / N** resolution is that the number N is number of revolutions in required time signal, from which the spectrum is made.

**Example!** The speed is 25 Hz. The entered resolution is **speed / 4** (it means that time signal contains 4 revolutions), i.e. 6.25 Hz. The line bandwidth in FFT will be 6.25 Hz. It means, that speed line contains all frequencies in the interval (21.875, 28.125). If any disturbing frequency is in that interval, then higher resolution must be used, for example **speed / 8**.



**Attention!** When you select higher resolution (for example speed / 64 or even speed / 1024) then more revolutions must be taken and you will wait for results longer time. The higher resolution means longer time signal for evaluation. We do not recommend using always the maximum value, because you will wait for results longer (much longer). Use the high resolution only in cases, when your signal contains two close frequencies and you need to separate them.

**Resolution in orders.** The resolution value in order analysis is connected with the number of revolutions similarly as resolution in frequency spectrum is connected with the number of seconds. Resolution in frequency domain can be expressed as  $\Delta f = 1 / T$ , where T is the number of seconds per FFT record. Similarly, resolution in order analysis can be expressed as  $\Delta \text{ord} = 1 / \text{rev}$ , where rev is number of revolutions per FFT record. This resolution is defined in orders. If you want to express the order analysis resolution in frequency unit you need to multiply the resolution in orders by the speed frequency. Therefore, the value of resolution is entered as the fraction of speed frequency and the required number of revolutions is displayed in the note below the resolution value.

### ***Frequency (speed, user)***

The frequency value for amp+phase and phase shift measurement can be entered manually (user) or the speed frequency from a tach sensor can be used.

### ***Manual Entry***

If you want manually enter the value, then select **Manual Entry = yes**. All manual inputs are required before the measurement. The new window for each one appears.

## ***Next Meas functions***

Next measurement functions are almost the same as for set (mentioned in previous chapter) – it is copy measurement, edit measurement, etc. These functions are described below.

### ***Copy Meas***

Copies the selected measurement to the new one.

### ***Edit Meas***

Enables changes in measurement properties.

### ***Delete Meas***

Deletes selected measurement.

### ***Meas info***

Displays measurement properties.

### ***Limits***

You can define limit values for static measurement types (overall, speed, dc, ...). Limits give a notice to you when a measured value is over some critical value. During the measurement and also during examining the measured values, the appropriate alarm is displayed in graph of measurement with defined limits. The alarm informs you about the severity of the measured value.

Each **limit value** divides a numerical axis into two intervals, numbers bellow the limit value and numbers above it. You can edit the **alarm** for each interval. Alarm represents the severity or color for the values measured in the interval. You can choose one from four severities for the alarm, **Ok** signaled with green color, **Warning** signaled with yellow color, **Alert** signaled with orange color and **Danger** signaled with red color. It's up to you what severity you assign to which interval. The particular alarm is displayed when the measured value is in appropriate interval. You can define more than one limit values and divide the numerical axis into more intervals.

In the example bellow, we have defined two limit values, 1 and 4 mm/s. We have defined the alarm bellow 1 mm/s as *Ok* (green color), the alarm between 1 and 4 mm/s as *Warning* (yellow color) and the alarm above 4 mm/s as

*Danger* (red color). In the first picture, you can see an actual measured value 2.61 mm/s which is greater than 1 and less than 4 (displayed as > 1, < 4 mm/s on the right side) and thus signaled as yellow color. The second picture shows a trend of values. You can see two limit lines in the trend, a yellow line on 1 mm/s and a red line on 4 mm/s. They represent the defined limit values and their colors correspond the alarms above the limit. Each value in the trend is drawn as a small colored circle whose color corresponds the alarm.

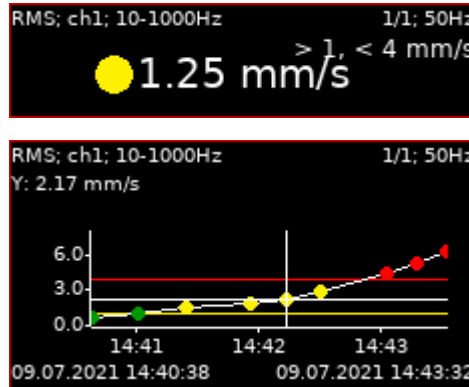

There are 3 ways how to create limits.

### Adash Limits



The limits are derived from Adash rules, which are developed for many years of Adash history. These limits require to know the speed value. Adash limits are available for two data cells types:

- velocity readings in frequency interval 10-1000Hz, which is very well suited for detecting the overall condition of the machine  
**Note!** fmin lower than 10 Hz is also accepted, it means Adash limits can be also used for velocity measurements with fmin lower than 10 Hz.

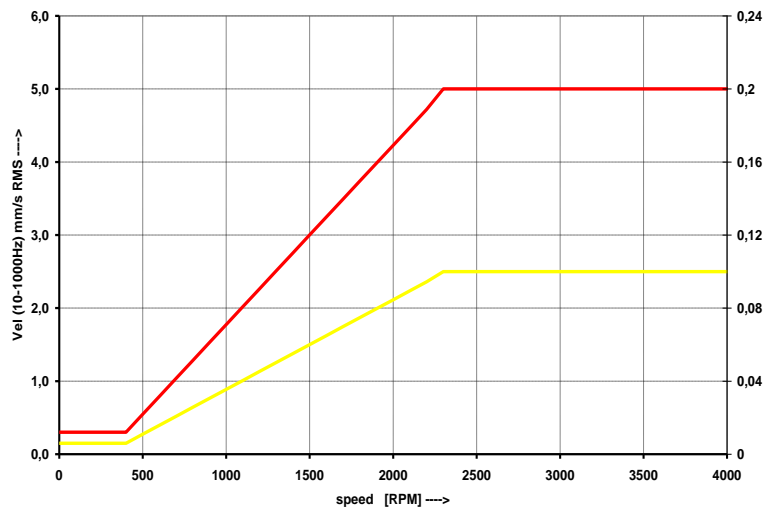

- acceleration readings in frequency interval 500 - 16 000 Hz, which is very well suited for detecting the bearing condition  
**Note!** fmin lower than 500 Hz and fmax higher than 16000 are also accepted, it means Adash limits can be also used for acceleration measurements with fmin lower than 500 Hz and fmax higher than 16000 Hz

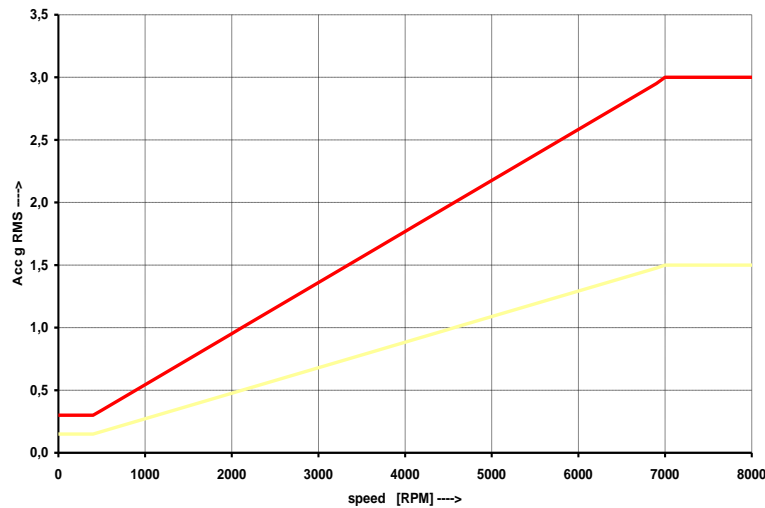

These limit values may be too or too little strict for some machines. Therefore, you can adjust them using the **Limits Multiplier**. Values greater than one increase the limits values and values less than one decrease them. A value of one means the limit remains as shown in the graphs above.

On following figures, you can see the effect of the multiplier. The first graph shows an alarm when the multiplier is set to 1. The second graph shows the same measurement, however this time the multiplier is set to 2, which means the limit value is twice as high as before. This means the limit is less strict and the alarm level is twice lower. The third case shows the situation with the multiplier set to 0.5.

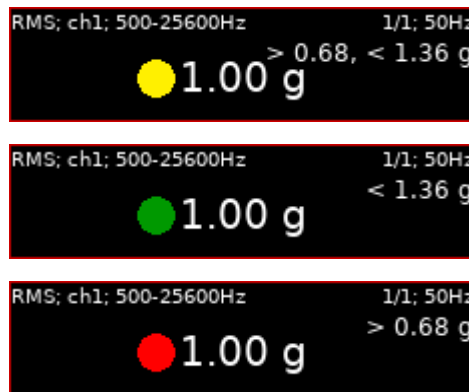

**Note!** For Adash limits, only the small colored circles are used in trends, the limit lines are not displayed. It is because of the relation to speed. Each reading can have different speed and therefore different limits.

**ISO 10816**

|                    |           |
|--------------------|-----------|
| Type               | ISO 10816 |
| Machine Group      | 1         |
| Machine Foundation | rigid     |

The limits are defined according the ISO 10816 standard and are available only for velocity readings in frequency interval 10 – 1000 Hz. The Machine Group and Machine Foundation has to be defined according to the ISO 10816 standard.

- **Group1:** Large machines (rated power above 300kW) with a shaft height greater than 315 mm.
- **Group2:** Medium-sized machines (rated power from 15 kW to 300 kW) and electrical machines with a shaft height between 160 and 315 mm.
- **Group3:** Pumps with multivane impeller and with separate driver with rated power above 15 kW.
- **Group4:** Pumps with multivane impeller and with integrated driver with rated power above 15 kW.

**Note!** The severity in ISO limits are marked also by letter A, B, C, D. Used group and foundation is also displayed in graph.

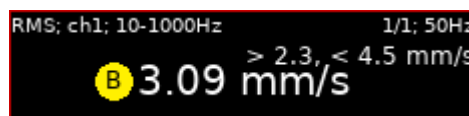

### User

User can define your own limits.

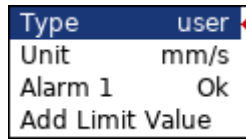

By default, there is no limit value defined yet and the Alarm is set to *Ok* for all measured values. It is same as in DDS dialog for limits.

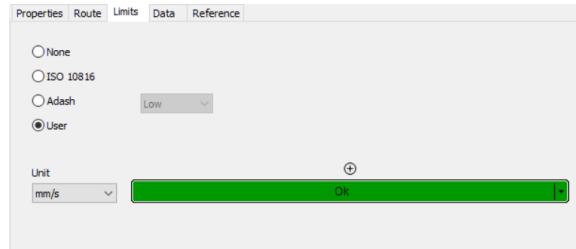

You can add a limit value using an **Add Limit Value** item and enter the value (eg. 1).

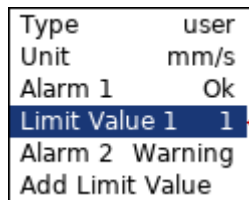

Now you have defined one limit value (1 mm/s) which divides a numerical axis into two intervals (bellow 1 mm/s and above it). You can define alarm for each interval. Alarm 1 defines the alarm bellow the Limit Value 1 and Alarm 2 defines the alarm above the Limit Value 1. The same think can be done in DDS by clicking on ⊕ symbol and entering the number.

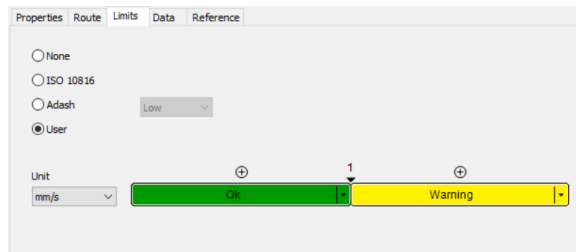

Same way you can add any number of limit values.

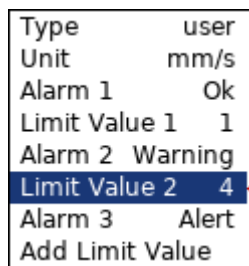

Limit values can be also edited or deleted using an appropriate **Limit Value** item.

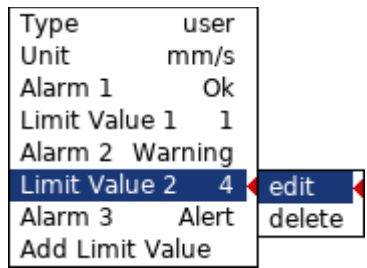

Alarms are defined using an appropriate **Alarm** item.

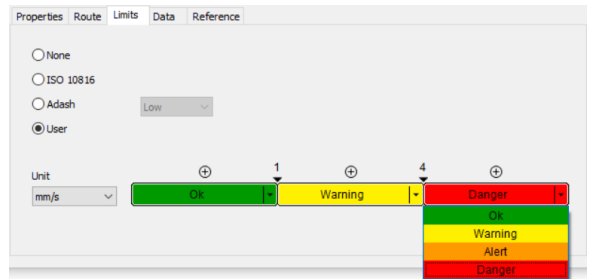
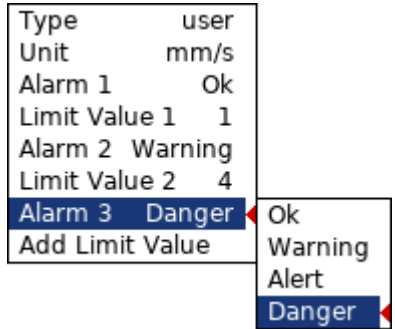

**Note!** You can assign alarms in any order. It's not required the Ok alarm to be the lowest. Eg., for displacement measurements, there is often the Ok alarm in the middle and Warning and Alert alarms are assigned to lower and higher intervals.

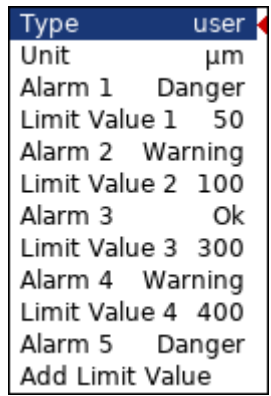

## Functions for Set

Next functions are available, when the Set is opened (it means the graphs are displayed).

### Save data

It saves last measured data. When you close the Set without saving, the measured data will be lost.

### Clear data

Deletes all saved data from the set.

### **View Trend/ View Actual**

The switch for displaying of last measured data (Actual) and data saved in memory (Trend).

### **Clear Last Data (if the trend is displayed)**

deletes last measured data in measurement point or set (according of displayed data).

## **Export**

The next menu appears under 'Export'. ('Export' option is available once you have measured some values – it is greyed out for the new measurement created with no values measured. Same as option 'Save data').

### **Export to CSV**

You have few options here.:

**Export to csv:** This option saves one selected measurement in CSV format (not available for all types).

**Export to csv (all):** This option saves all measurements in set in CSV format (except types, where CSV is not available).

*CSV means comma-separated values. It is the basic format for tables (MS Excel). We use semicolon as separator.*

Exported files are saved to **va3/csv** folder. Files are saved to sub-folders. In case of route export is the sub-folder name created by route name\_machine name\_point name. In case of runup is added the date and time (**set\_yyyy\_mm\_dd\_hh\_mm\_ss**).

**Export of last measurement (actual):** The name has the following format:

**position-number\_name\_yyyy\_mm\_dd\_hh\_mm\_ss\_msec.csv.**

The first line in the file contains information:

**u:** unit name (A4300-#####, ##### = serial number)  
**ch:** channel  
**n:** number of samples (lines)  
**d:** delta x, step on X axe between samples  
**eu:** engineering unit  
**t:** date and time of measurement  
**s:** speed

**sensor:** if name of the sensor is defined (see AC sensors/Name) it is shown here also

**note:** Header can contain also note which is included automatically from Set notes. Only notes created after measurement was taken are included into csv header.

Next lines contain measured data. Each line can contain several values.

|                     |  |
|---------------------|--|
| <b>time</b>         | time [s]; value; trigger;                          |
| <b>ACMT</b>         | time [s]; value; trigger;                          |
| <b>orbit</b>        | time [s]; valueA; valueB; valueX; valueY; trigger; |
| <b>spectrum</b>     | frequency [Hz]; amplitude; phase [°];              |
| <b>orders</b>       | order; amplitude; phase [°];                       |
| <b>1x amp+phase</b> | 0; amplitude; phase [°];                           |
| <b>phase shift</b>  | 0; B/A; $\Phi_B - \Phi_A$ [°]; coherence;          |
| <b>center line</b>  | 0; valueA; valueB; valueX; valueY;                 |
| <b>other</b>        | 0; value;  |

**Export of trends (history):** If you used **View trend** function, then for static measurement is exported complete trend to one csv file. The only one displayed dynamic measurement is exported - not all measurement in trend. The file name is **position-number\_name.csv**. The first column always contains date and time of measurement.

## **Graph Max/Min**

Maximizes or minimizes the selected graph to the whole screen or returns back to the initial screen with more graphs.

## Graph Properties

This menu item displays various options for graph displaying. The options depend on graph type.

### Scale

This is applied for *time*, *g-demod time (time waveforms)*, *orbit*, *spectrum*, *ACMT*. You can choose one of the following options:

- max** Y autoscale for every new graph, but the range is increased when higher value comes
- auto** Y autoscale according data values of every new measurement
- user** user defines Y range for all graphs independently of data values

### View orbit

This is applied for *orbit*. You can choose one of the following options:

- orbit** standard 2D orbit view
- AB** two input time signals from channels A and B
- XY** two time signals transferred to X and Y axis

### Axis X, Y

This is applied for *spectrum*, *g-demod spectrum*. You can choose one of the following options:

- Axis X** lin, log
- Axis Y** lin, log, dB

### Detect Type

It is Y axis type. Applied for *spectrum*, *g-demod spectrum*, *orders*. You can choose one of the following value types:

- RMS, 0-P, P-P** P is for peak.

**Note!** When the spectrum is displayed first time, then the global **Global/Detect Type** is used. You can change it here to other type.

### Graph Lines

This is applied for *spectrum*, *g-demod spectrum*. You have two options to choose:

**continuous, discrete** the spectrum can be drawn as line through the tops of line or as discrete vertical line for each frequency. See example on the picture below.

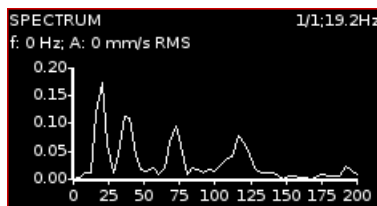

continuous

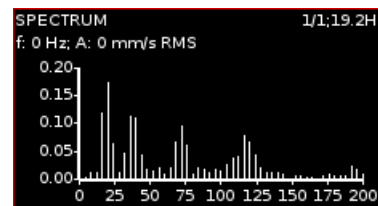

discrete

### Peaks List

yes, no

Applied for *spectrum*, *g-demod spectrum*. Shows frequency and amplitude of 3 highest spectrum lines.

**Note!** The graph must be maximized in order to the peaks could be shown.

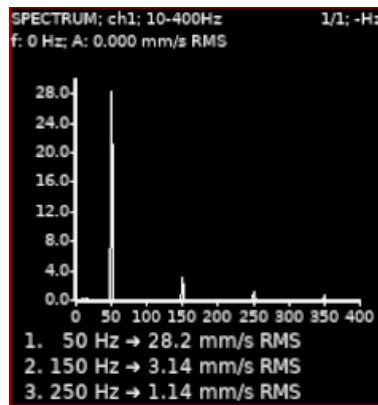

### Analyzer Buttons

Let's describe special button's function in analyzer module.

#### F3 button

This button has two functions – *START/STOP* – it starts/stops the readings (measurements).

#### Shift

It switches the functions of arrow buttons. It is following button.



How do you know which function do arrow buttons have at the moment?



How to change function of the arrows? When measurement set is opened, press repeatedly **SHIFT** button. Notice that mode of the buttons has changed.

Name of the mode is written in top left corner of the screen (seen in the screenshots above). It is always one of the following options.:

- Selection** – use the up and down arrow buttons to change the active graph (one graph is always selected),
- Position** – use the up and down arrow buttons to change the position (order) of graphs,
- Cursor** – use the left and right arrow buttons to move with cursor,



**Zoom** – the arrow buttons make zoom-in or zoom-out functions on X or Y axis,  
**Move** – when the zoom-in is applied, then you can move with the signal by the arrow buttons,  
**Trend** – when the trend is displayed, the left and right arrow buttons change the time.

### FASIT

In case of FASIT measurement, the speed detection is done before the measurement itself (for more information see chapter: **Speed detection**).

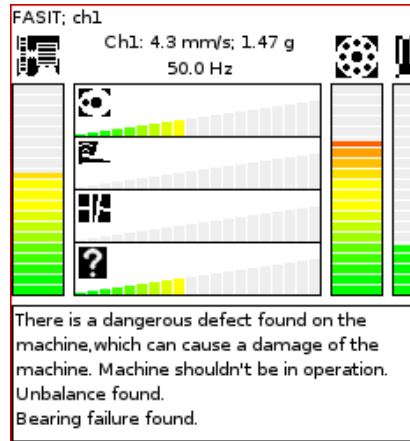

### Overall

Typical example of the overall measurement is RMS value. See picture below. We measure RMS value of vibration velocity in frequency range 10-1000 Hz.

| Type           | overall       |
|----------------|---------------|
| Channel        | 1             |
| Unit           | mm/s          |
| Detect Type    | RMS           |
| Fmin [Hz]      | 10            |
| Fmax [Hz]      | 1000          |
| Fsampling [Hz] | 4096          |
|                | by fmax       |
| Samples        | 4096          |
|                | t = 1 s       |
| Averaging      | linear        |
| Avg            | off           |
|                | total t = 1 s |

**Note!** Overall measurement is such a measurement where you get one value. This value is a great pointer to evaluate machine's condition. It may be the easiest way how to inform the user that something is ongoing on the machine. Typical example is RMS value mentioned above.

The first row (*RMS; ch1; 10–1000 Hz*) contains used parameters. Number 1/1 on the right is parameter for averaging. The next parameter – 25.1 Hz on the right – is the speed, because the tachometer was used.

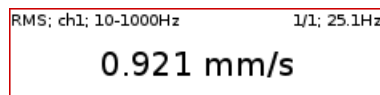

Change Detect Type to **0-P**. We get following value.

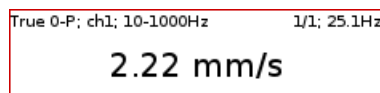

**Note!** Keep in mind that the formula  $0-P=1.414 \cdot RMS$  is not valid for every signal. That formula is valid only for **pure sine wave!** The true RMS and true peak measurement are generally independent. The only valid rule is that the peak value is **always bigger** than RMS value.

Change Avg to 8. It means that 8 individual values (1 sec length) will be taken and result will be **linear average** of them ( $RV = (V1 + V2 + \dots + V8) / 8$ ). You can see the indicator in top right corner (as mentioned).

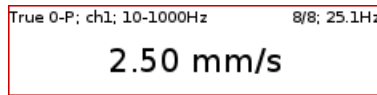

Let's change averaging back to off and change the samples to number 32768. The measurement will be 8 sec long.

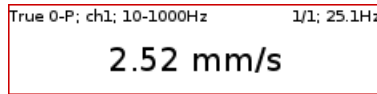

You can see that the result is little bit different than the previous one. Why? Answer is simple – maximum 0-P value in 8 sec signal is not the same as the average of 8 0-P values (1 sec each).

Let's change detect type back to **RMS**.

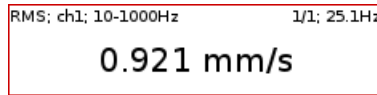

Now change the length to 1 sec (4096 samples) and Avg=8.

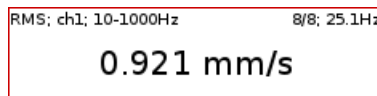

You see the same result. Both values are **equal**. The meaning of **RMS differs** from peak values. The **RMS value depends only of total time of measurement**. It does not care if one long signal was taken or several shorter signals were averaged.

## Spectrum

|           |                       |
|-----------|-----------------------|
| Type      | spectrum              |
| Channel   | 1                     |
| Window    | hanning               |
| Unit      | mm/s                  |
| Fmin [Hz] | 10                    |
| Fmax [Hz] | 400                   |
|           | fs = 1024 Hz          |
| Lines     | 1600                  |
|           | t = 4 s, df = 0.25 Hz |
| Averaging | linear                |
| Avg       | 8                     |
|           | total t = 32 s        |
| Overlap   | 0%                    |

The **fs** below the **Fmax** means sampling frequency. The **t** below the **Lines** is the time signal length, which is used for one spectrum. The **df** is the frequency resolution between lines.

**Note!** Sampling is used for signal discretization in the time domain. Sampling frequency should be at least 2 times higher than signal frequency (low sampling frequency may cause signal distortion). Adash devices use sampling frequency 2,56 times higher than **Fmax** value.

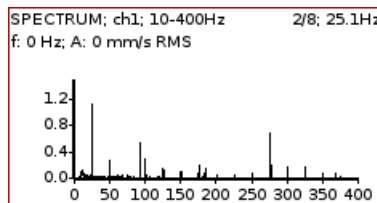

The information in top right corner contains averaging (2/8) and speed (25.1Hz).

The **Band fmin** defines the frequency of HP filtering, which is used for DC part removing. If you do not expect any important lines below 10Hz, use the 10 instead 1. The initialization time of 1Hz filter is much longer then 10Hz.

The **Overlap** enables to you to make the averaging faster. E.g., 75% overlap means, that ending 75% of actual time signal + 25% of new signal is used for next average.

**Note!** The frequency spectrum is the dependence of the amplitude of the measured quantity on the frequency. You can see frequencies included in the signal shown in the spectrum with their amplitudes.

### Time

| Type           | time          |
|----------------|---------------|
| Channel        | 1             |
| Unit           | mm/s          |
| Fmin [Hz]      | 10            |
| Fmax [Hz]      | 1000          |
| Fsampling [Hz] | 4096          |
|                | by fmax       |
| Samples        | 8192          |
|                | t = 2 s       |
| Avg            | off           |
|                | total t = 2 s |

Similar parameters like for overall are used. Fsampling is sampling frequency. It may be determined automatically by fmax or manually set (see *Fsampling*).

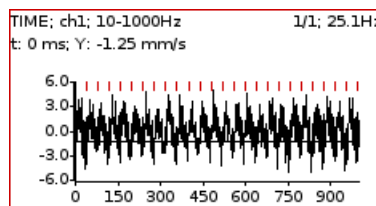

The red short vertical lines at the top of graph indicates the tach inputs.

For averaging you need to set the Menu / Trigger / Trigger Source = tach. Then define the number of averages.

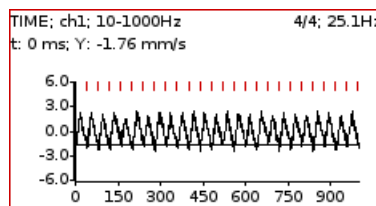

You see the effect of averaging in decreasing of signal noise. The speed frequency is better seen.

### g-demod overall

| Type             | g-demod overall  |
|------------------|------------------|
| Channel          | 1                |
| Unit             | g                |
| Detect Type      | RMS              |
| DEMODO fmin [Hz] | 500              |
| DEMODO fmax [Hz] | 25600            |
|                  | fs = 65536 Hz    |
| Samples          | 8192             |
|                  | t = 125 ms       |
| Averaging        | linear           |
| Avg              | off              |
|                  | total t = 125 ms |

It is very similar to standard overall measurement. The signal is filtered in set range (*DEMODO fmin*, *DEMODO fmax*) and demodulated then.

The Unit cannot be changed, only the acceleration g unit can be used. No integration of signal is enabled.

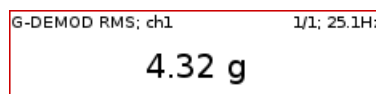

### ***g-demod spectrum***

|                 |                                      |
|-----------------|--------------------------------------|
| Type            | g-demod spectrum                     |
| Channel         | 1                                    |
| Window          | hanning                              |
| Unit            | g                                    |
| DEMOM fmin [Hz] | 500                                  |
| DEMOM fmax [Hz] | 25600                                |
|                 | $f_s = 65536 \text{ Hz}$             |
| Fmax [Hz]       | 800                                  |
| Lines           | 800                                  |
|                 | $t = 1 \text{ s}, df = 1 \text{ Hz}$ |
| Averaging       | linear                               |
| Avg             | 8                                    |
|                 | total t = 8 s                        |
| Overlap         | 0%                                   |

**Example:** the demodulated frequency 132 Hz with harmonics. No integration of signal is enabled.

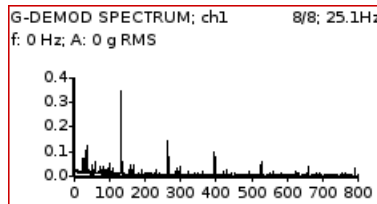

**Note!** Demodulated spectrum is mostly used for bearing faults.

### ***g-demod time***

|                 |                          |
|-----------------|--------------------------|
| Type            | g-demod time             |
| Channel         | 1                        |
| Unit            | g                        |
| DEMOM fmin [Hz] | 500                      |
| DEMOM fmax [Hz] | 25600                    |
|                 | $f_s = 65536 \text{ Hz}$ |
| Samples         | 8192                     |
|                 | $t = 125 \text{ ms}$     |

This function enables to see the signal, when the standard envelope demodulation is used. The Unit cannot be changed, only the acceleration g unit can be used. No integration of signal is enabled.

### ***amp+phase***

The amplitude and phase on speed frequency or its multiple (order).

|            |                      |
|------------|----------------------|
| Type       | amp+phase            |
| Channel    | 1                    |
| Unit       | $\mu\text{m}$        |
| Averaging  | linear               |
| Avg        | 8                    |
| Frequency  | speed                |
| Order      | 1                    |
| Resolution | speed / 4            |
|            | $t = 4 \text{ revs}$ |

By default, ~~the~~ amp+phase is measured on speed frequency (order = 1). However, you may define any value as the order for the measurement. For example, if you want to measure amplitude and phase on 1/3x speed frequency, then you enter the order as 0.333333. The order value is announced in the graph's information line, the "1x" on the picture above means the order value is 1. Thus, the speed frequency is used for measurement.

**Note!** Remember to set the appropriate resolution according to the used order. See Resolution for more details.

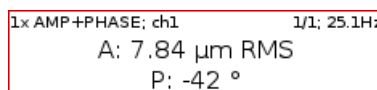

### Orbit

|                  |               |
|------------------|---------------|
| Type             | orbit         |
| A channel number | 1             |
| B channel number | 2             |
| Unit             | µm            |
| Fmin [Hz]        | 10            |
| Fmax [Hz]        | 800           |
| Fsampling [Hz]   | 2048          |
| Samples          | 4096          |
|                  | by fmax       |
|                  | t = 2 s       |
| Avg              | off           |
|                  | total t = 2 s |

Orbit measurement is used for measuring the vibration of the shaft around its position in the bearing. It is necessary to have 2 sensors – sensor A and B.

Correct sensors position (angles) must be set for correct calculations (see sensors definition).

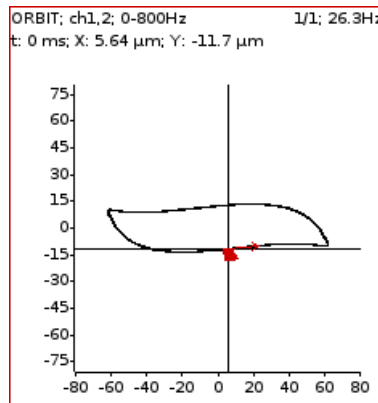

### Speed

Choose type *speed*. The machine speed (revolutions) is measured.

|      |       |
|------|-------|
| Type | speed |
| Unit | Hz    |
| Avg  | off   |

When a tacho sensor is used (connected to the tacho / external input), then the impulses are added to all AC inputs. In the time signal graph are marked by short red lines.

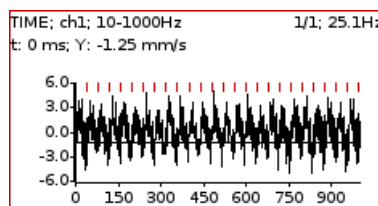

The speed measurement is taken 8 times in every second. The value is evaluated from 3 tacho events in time signal. When the averaging is required, then more values is used. But keep in mind that only 8 values is taken in one second.

|         |     |
|---------|-----|
| SPEED   | 1/1 |
| 25.1 Hz |     |

## ACMT

| Type         | acmt    |
|--------------|---------|
| Channel      | 1       |
| Unit         | g       |
| Detect Type  | PEAK    |
| Fmin [Hz]    | 500     |
| ACMT FS [Hz] | 1024    |
| Samples      | 1024    |
|              | t = 1 s |

It enables to measure long time signals and compress them. It is used when you need high frequency range, for example 25.6kHz. The highpass filtering is used (Band fmin). The basic property of ACMT is resampling initial high frequency sampling (64kHz) to low ACMT FS frequency sampling (usually 1kHz). The compressed ACMT time signal can keep the RMS or TRUE PEAK of original signal. Use the **Detect Type** parameter for selection. RMS value enables better trending.

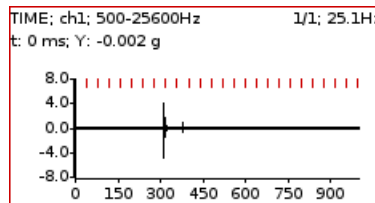

The original time signal 1 sec long, which contains shock. Signal contains 65536 samples.

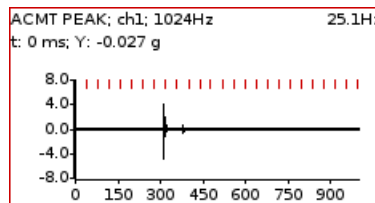

The ACMT time signal. You can see the same shock, but signal contains only 1024 samples.

## Orders

This name means order analysis.

| Type       | orders     |
|------------|------------|
| Channel    | 1          |
| Unit       | µm         |
| Orders     | 1-10       |
| Averaging  | linear     |
| Avg        | off        |
| Resolution | speed / 4  |
|            | t = 4 revs |

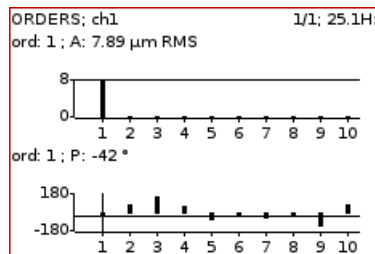

## Phase shift

| Type             | phase shift |
|------------------|-------------|
| A channel number | 1           |
| B channel number | 2           |
| Avg              | off         |
| Frequency        | speed       |
| Order            | 1           |
| Resolution       | speed / 4   |
|                  | t = 4 revs  |

Measurement of phase shift between two channels, amplitude ratio, and coherence on speed frequency or on manually entered frequency.

| PSHIFT: ch1,2; otáčky     | 8/8; 25.1Hz |
|---------------------------|-------------|
| $\Phi_B - \Phi_A$ : -45 ° |             |
| B/A: 2.13                 |             |
| coh: 1.000                |             |

The result contains:

- phase shift value in degrees,
- amplitude ratio ( ampl B/ ampl A),
- coherence

If the phase shift is reliable, then the coherence must be bigger then 0.8.

By default, the phase shift is measured on speed frequency (Order = 1). However, you may define any value as the Order for the measurement. For example, if you want to measure amplitude and phase on 1/3x speed frequency, then you enter the order as 1/3. The order value is announced in the graph's information line, the "1x" on the picture above means the order value is 1. Thus, the speed frequency is used for measurement.

Furthermore, you may enter any frequency using the Frequency parameter. In this case, the order parameter is not available, the Resolution parameter is entered as a fraction of the frequency and the entered frequency is announced by the "f:" label in graph's information line.

## DC

The direct DC signal can be measured by this option.

| Type         | dc     |
|--------------|--------|
| Manual Entry | no     |
| Channel      | 1      |
| Unit         | °C     |
| Averaging    | linear |
| Avg          | off    |

| DC: ch1 | 1/1; -Hz |
|---------|----------|
| 23.5 °C |          |

If you want manually enter the value, then select **Manual Entry = yes**. All manual inputs are required before the measurement. The new window for each one appears.

| Enter value [°C] | 123 |
|------------------|-----|
| Manual Entry: °C |     |
| 25.3             |     |

## IR temperature

Temperature is measured with IR sensor. The sensor is on top panel of the instrument.

| Type | ir temperature |
|------|----------------|
|------|----------------|

| IR TEMPERATURE | -Hz |
|----------------|-----|
| 23.3 °C        |     |
| 74.0 °F        |     |

## Center line

This measurement is often used for turbines. The **Center line** values define the static position of shaft in bearing. The signals from proximity sensors must be connected to DC channels. We need to remove the AC part and to hold the DC part. The DC inputs work in that way.

| Type             | center line   |
|------------------|---------------|
| A channel number | 1             |
| B channel number | 2             |
| Unit             | $\mu\text{m}$ |
| Avg              | off           |

The Center line is related to the orbit measurement. We also need two sensors with known angles of mounting. Correct dc sensors positions (angles) must be set for correct calculations (see Sensors definition). While in orbit we see the shape around the (0,0) position, in the center line we see the position of shaft center without shape of orbit.

| CENTERLINE: ch1,2      | 1/1; -Hz |
|------------------------|----------|
| A: 22.1 $\mu\text{m}$  |          |
| B: 2.94 $\mu\text{m}$  |          |
| X: -13.5 $\mu\text{m}$ |          |
| Y: -17.7 $\mu\text{m}$ |          |

Two couples of values are displayed – A+B and X+Y. The A, B values represent distances of sensors from the reference position defined by offset value. The X, Y values represent that positions according the Cartesian X, Y coordinates (The position (0,0) correspond the position, where A, B are equal their offsets).

## S-max

| Type             | smax          |
|------------------|---------------|
| A channel number | 1             |
| B channel number | 2             |
| Unit             | $\mu\text{m}$ |
| Fmin [Hz]        | 10            |
| Fmax [Hz]        | 800           |
| Fsampling [Hz]   | 2048          |
| Samples          | 4096          |
|                  | by fmax       |
|                  | t = 2 s       |
| Averaging        | linear        |
| Avg              | off           |
|                  | total t = 2 s |

| SMAX: ch1,2; 0-800Hz | 1/1; 25.1Hz |
|----------------------|-------------|
| 51.0 $\mu\text{m}$   |             |

It is standard S-max measurement as the **maximum vector amplitude of displacement**. Correct sensors positions (angles) must be set for correct calculations as for standard orbit graph (see Sensors definition).

## Ultrasound

Type ultrasound

| ULTRASOUND         | -Hz |
|--------------------|-----|
| Level: 23.3 dB     |     |
| Shock Factor: 4.15 |     |

Two values are displayed. The **Level** of sound in dB (30 - 50kHz range) and **Shock Factor**. The Shock factor is defined as Peak value divide by RMS value. It means value 1.4 for pure sine. Higher values means that transient shock events are in the sound signal.

**Note!** The ultrasound sensor (microphone) required.

There is detailed description in the Ultrasound module chapter.



## Record

|                           |                    |
|---------------------------|--------------------|
| Type                      | record             |
| Fs [Hz]                   | 65536              |
| Frequency range: 25600 Hz |                    |
| AC1                       | on                 |
| AC2                       | off                |
| AC3                       | off                |
| DC1                       | off                |
| DC2                       | off                |
| DC3                       | off                |
| Tacho                     | off                |
| Length [minutes]          | 1                  |
| Available space:          | 1000 MB / 01:21:18 |
| Start of Rec              | freerun            |

Creates and saves the record. After the download to PC it is ready for using with Virtual Unit. There is detailed description in the Recorder module chapter.

RECORD  
00:00:12 / 00:01:00

## Route

The route module is used for route measurements. DDS software is required for creation of route measurement structure. For more details see also DDS manual – all functions are described there.

### **Load the route to the instrument**

Open the database in DDS which you want create the route from. Open the instrument window (**Route – A4300 VA3 Pro**).



The route window appears (left bottom corner).

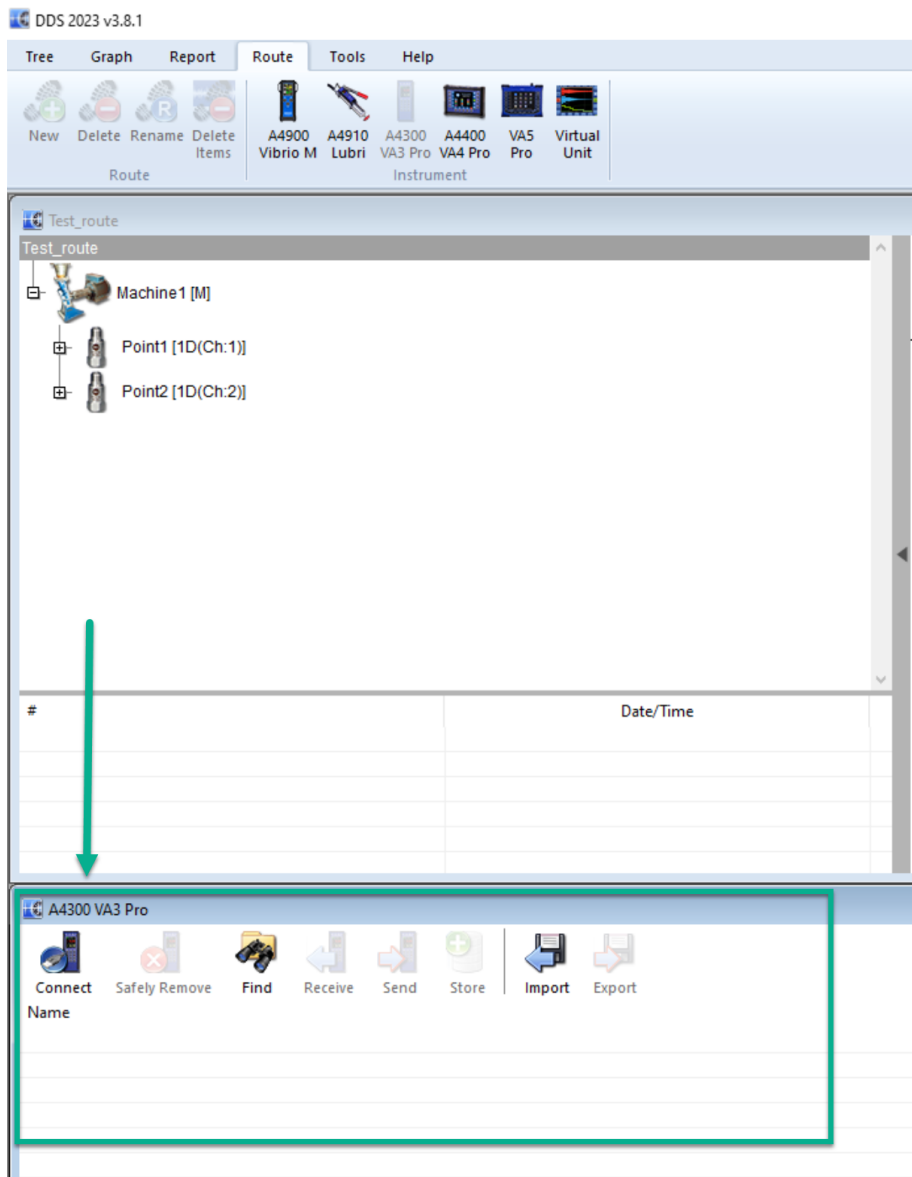

Connect the instrument with a **USB** cable.

Press the **Connect** button. The message window with connection process description should appear.

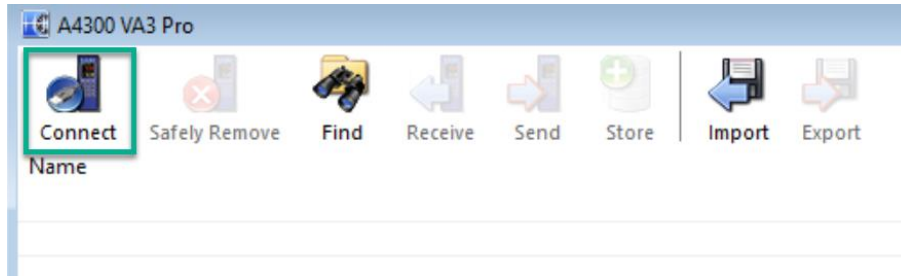

The list of data saved in the instrument appears.

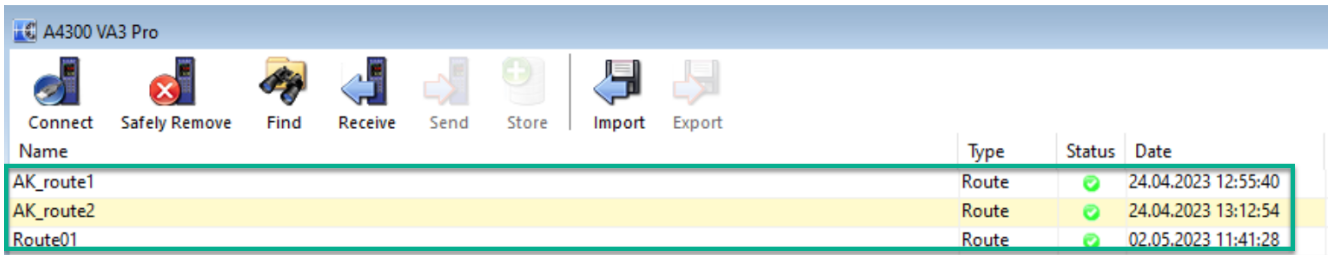

Move the required points from the DDS tree to the route window (use mouse **Drag and Drop**).

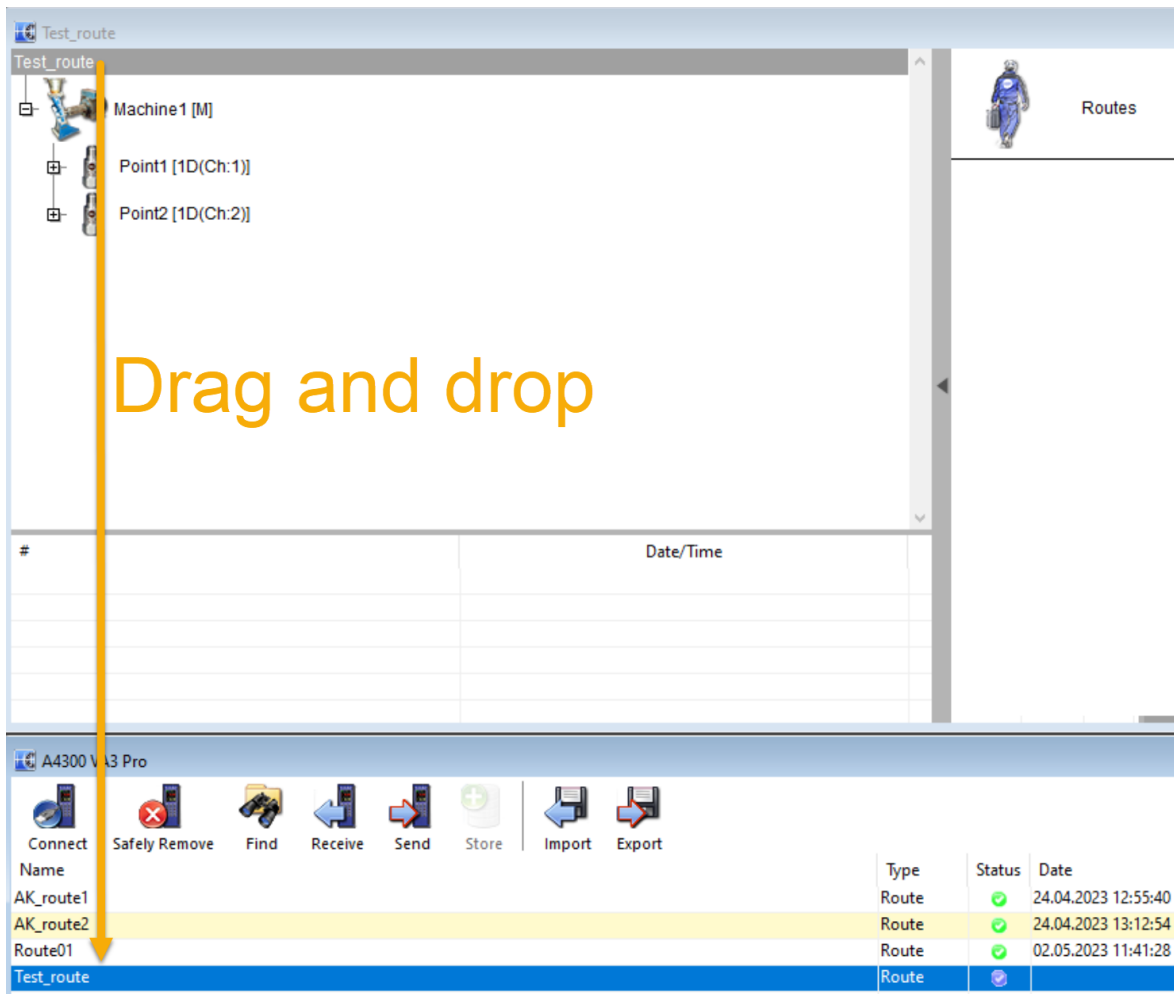

Press the **Send** button. The route data will be loaded from the computer to the instrument.

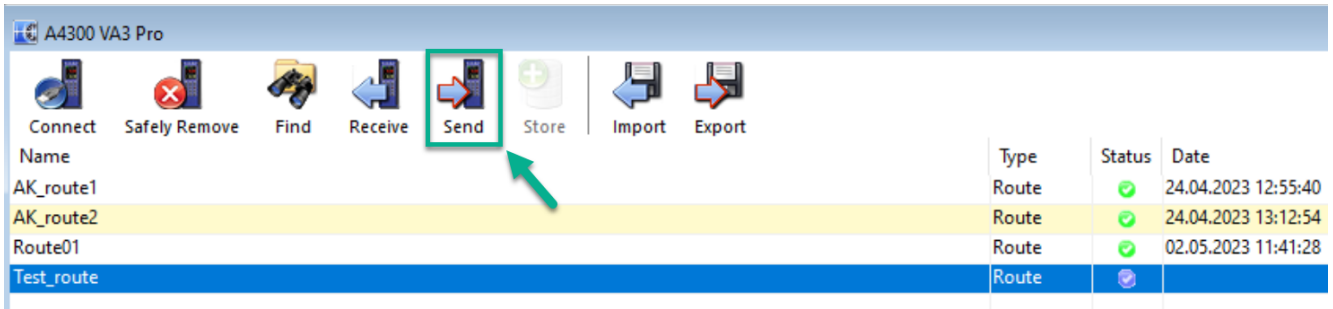

### Route creation in VA3 device

You can create route tree also directly in VA3 device. **BUT:** new database has to be created in DDS for it when you want to get the data from the device to DDS. See DDS manual for more information about this.

Go to **Route** module on VA3 main screen. You can see list of routes in device.

Press **F2** button (menu) and choose '**New route**'. Name it and take next necessary steps.

### Route readings

Select the **Route** module in VA3 Pro main screen. The list of routes in the memory is displayed. Select one route from the list (with arrow buttons) and press **OK** (F3 or button 5).

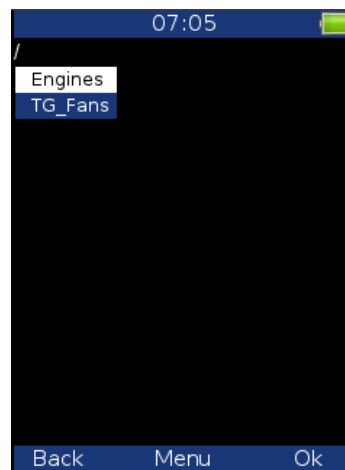

The list of machines appears. Choose one machine and with **OK** button (or with right arrow – button 6) display the list of measurement points.

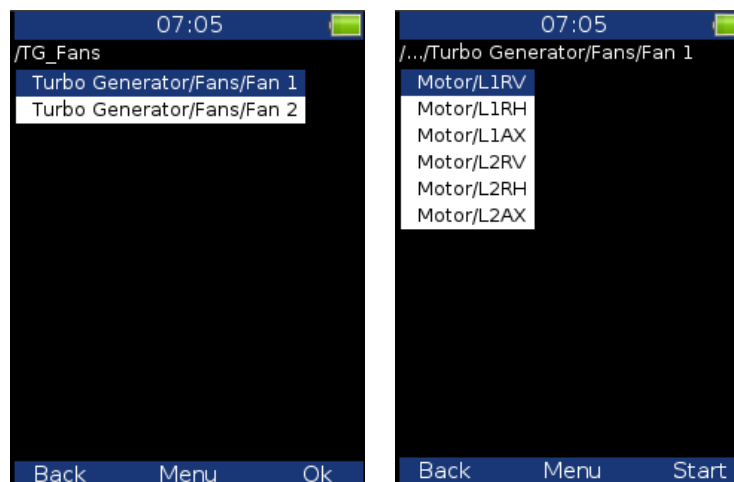

Now you can start the measurement by pressing **Start** (F3) or display the list of measurements defined in this point by pressing the right arrow button.

Use the **left arrow** button to return to the **previous** level in the tree.

When you press the Start button on the screen with the list of points, the graphs are displayed with the **No Data** message and the measurement begins.

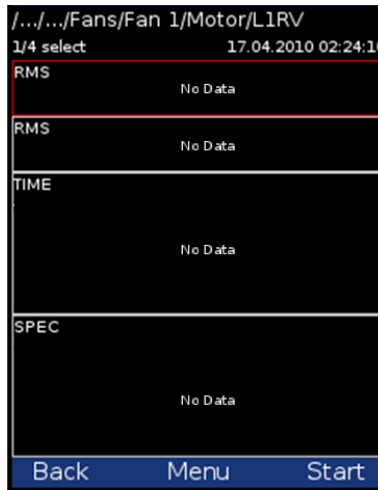

If the required sensor (defined in the route) is not compatible with the sensor connected to the channel input (Sensor's properties) the instrument displays a warning. If this happens change the sensor or use a different sensitivity and press **Continue**.

All measurements defined in the point should be taken now. The measured data are displayed on the screen.

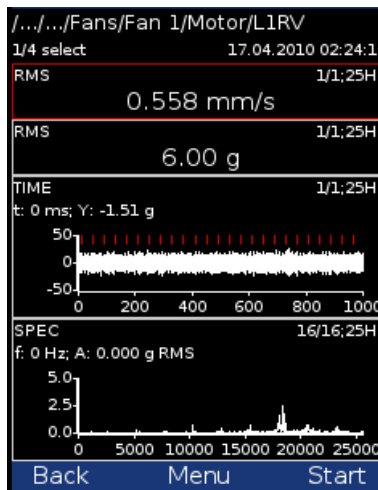

Press the **Back** button (F1) to return to the list of points. The measured point is labeled by the tick symbol '✓' (all defined measurements were taken) or by the exclamation mark symbol '!' (some readings were not taken due to error) or by the dot symbol '.' (measurement not complete).

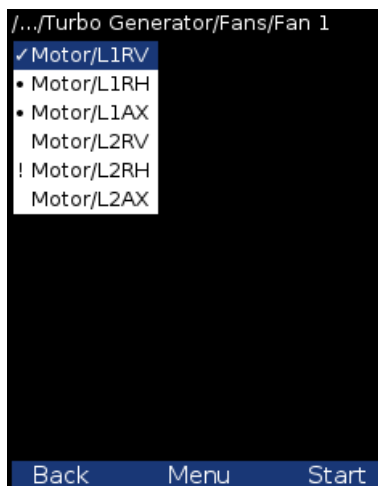

### Downloading the route to the PC

Open the instrument window in DDS (**Route – A4300\_VA3**). The route window appears. Connect the instrument to a USB port. The information with the message **'Connected to PC'** appears on the VA3 Pro screen. Press the Connect button in DDS. The list of readings saved in the instrument appears (data saved in the instrument).

Select the required route. Press the **Store** button. The data are transferred and saved to the database.

### Route Meas Mode

In DDS measurement point *properties / Other* tab, you may set the *Route Meas. Mode* property.

If **Single** is set, only one reading is taken and the measurement process is stopped.

If **Retrig** is set, the measurement process runs until the user presses the *Stop* button. No values are saved during the measurement. For both of these modes, it depends on the *Global Settings / Route Autosave*, whether the reading after finishing the measurement is saved or not.

If **Continual Saving** is set, the measurement process also runs until the user presses the *Stop* button. Moreover, all readings are saved regardless of whether the *Route Autosave* parameter is set or not. It is designed for short series of measured values. For example, you want to measure one elevator run or one run of a press machine. See more details in DDS manual.

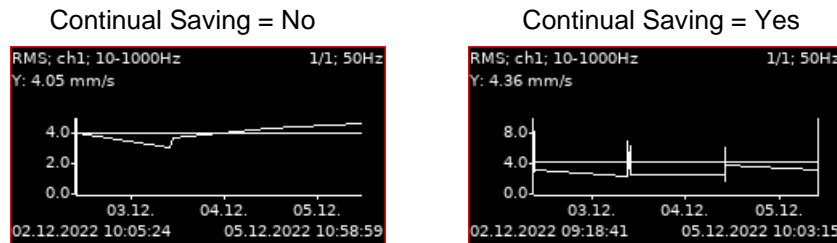

**Note!** Available interval is displayed on the status bar before the start of measuring. The instrument enables save up to 1GB of data on each measurement (if enough memory available), but the limit of 1 million values per point cannot be exceeded.

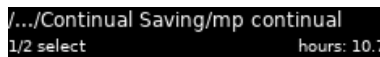

### Reference values

Reference values can be downloaded from DDS to VA3 for spectrum and overall measurements. These values are shown with the measured values (see picture below).

**Reference spectrum** is shown together with measured spectrum in the same graph.

**Overall reference value** is shown in the left side of the graph. It is signed with 'R' or like a line in the trend view.

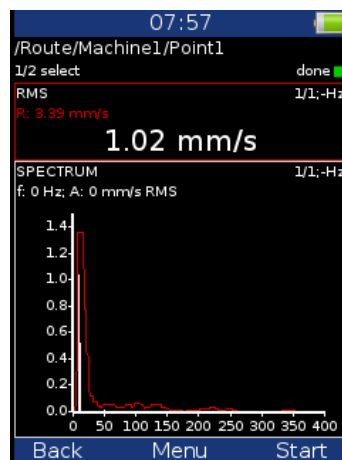

## Manual entry

The route may contain the measurements, which have to be entered manually (e.g., temperatures read from analogue display). The measurement with subtype **MANUAL** in DDS is defined. Before beginning of measurements from sensors (after you press START button) the window for manual input appears (one for each manual input).



You can skip the value entering. Until the field for value entering is empty, the **F3** button means **Skip**.

The measurement automatically begins after entering of all manual values. If you want to be able to cancel the measurement, set the **b2=1** in **Advanced** parameter. See chapter **Main menu / Global** for details.

## Notes

Select **Notes** item in Route menu.

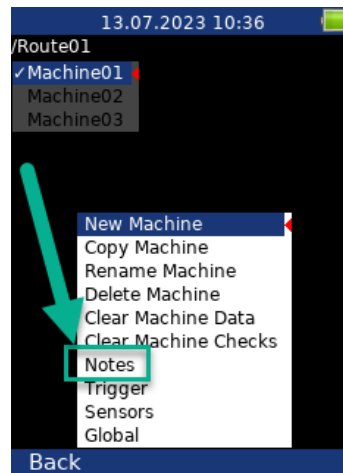

The list of notes for point appears. It is empty, when no notes were created yet.

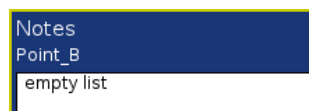

**New note:** use Menu – Add note. You can use one of the predefined notes or create your own.

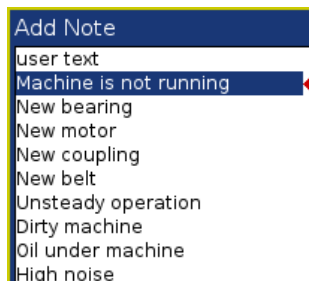

The predefined notes are saved in instrument in **va3/notes** folder. The individual file exists for each language. The user can modify the notes or can add his own notes. Use any software for text files edit.

Select one note from the list and press **OK**.

If you want to enter the text, then select **user** text item. You can also edit the note which was selected from the predefined list. Then press **OK**.

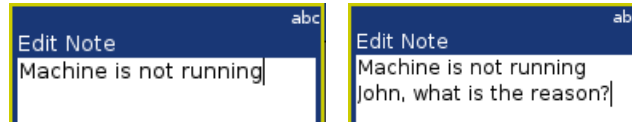

After pressing **OK** you return back to the list of notes. The new note appears in the list.

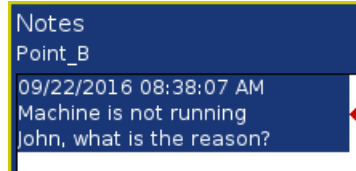

Use the **Menu / Edit Note** to edit the selected note from the list.

Use **Menu / Delete Note** to remove selected note.

Press **OK** to close the list.

If the note exists for the point, then the **N** letter is displayed behind the point name.

## Speed in the route

There are various ways how to get the speed and transfer it to DDS. The ways are described here in the order from the lowest priority to the highest priority.

### Speed entered in DDS

The **Default Speed** can be set in DDS as a machine parameter (**Tree Item Properties / Speed** tab). This value is sent to the instrument and it is used in place of tacho sensor value. The three options of **Default Speed** are available for the machine item.

**Entered value** - the value entered in Default speed is sent to the instrument. The value is used only for FASIT measurement. If the value is entered, then no speed detection is used.

**Detected** option runs speed detection before measurement (see the **Speed Detection** chapter).

**Manually Entered** option opens **Enter the speed** dialog, where you enter the value.

Detected or manually entered speed is valid for whole machine. Unless you close the machine item, the same speed value is used.

The **Default Speed** can be also set in other items, not only in the machine. In this case only numerical value is available. If you enter default speed value and in the same time you have set machine's default speed as **Detected** or **Manually Entered**, then the machine's setup has priority.

### Measured speed

If the speed is measured by tacho probe, it is saved always with data regardless the fact if there were already defined by one of the previous ways (speed entered in device or DDS).

Current entered or detected speed value (if defined) is displayed in information panel.

speed: 50 Hz

## Limits

In DDS, you can define limit values and alarm colors (see the DDS manual to find out how to do it). For static data cells, these limits are transferred into the instrument together with the route. Exceeding the limit values is signaled during the measurement and also in trends.

RMS; ch1; 10-1000Hz 1/1; 50Hz  
 > 1, < 4 mm/s  
 ● 1.25 mm/s



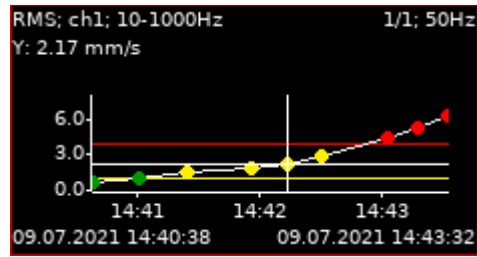

### **Route Buttons**

Buttons have same meanings as in the **Analyzer** module.

There is only one more functionality in **route** module. If arrow's function is set to **Trend**, then you can use up and down button to change displayed point while measured data are displayed.

## **Balancer**

The balancing process is based on standard measurements of amplitude and phase on the speed frequency. If you are not familiar with on-site balancing method, we recommend reading professional literature before you proceed.

### **Planes and points**

We would like to explain the difference between the words 'plane' and 'point'. The sensor is mounted to the point or points (dual channel reading). The trial mass and final masses are mounted to the plane or planes. Some people talk about measuring on planes, but this is not correct. In case of overhanging rotor there is no direct relationship between points and planes.

*We use the labels A and B for points and 1 and 2 for planes.*

### **Project**

Project is the base structure in balancer module. It corresponds to one balancing job. You can use the same project for repeated jobs on the same machine. Measured data will be rewritten.

Project contains all measured or entered data, which are used during the job. The typical scheme looks like the following steps:

- Create the project.
- Enter the parameters.
- RUN 1 - Initial measurement of the vibration amplitude and phase is taken at the required number of points.
- Place a trial mass on the plane. Repeat this step on the second plane if required.
- RUN 2 - Trial mass response measurement is taken. Repeat this step on the second plane if required.
- Place final masses put on all planes.
- RUN 3 – This checks the effect (success) of the balancing job.
- Trim - Additional trimming can be carried out for better results.

**Every step is displayed on its own screen. You can move between screens by pressing the left/right arrow buttons.** This movement enables you to return back anytime.

**Attention:** *When you return back to the job screens and take the reading again or enter the value, then the measured data will be erased in all screens after the current screen. The reason is simple; the implications are derived from every screen to the following screens. When you repeat the measurement, you change the parameters for those implications. That is why all the following screen implications must be removed and you have to take all the necessary readings again.*

### **Project list**

The list of saved projects or the Empty label is displayed on the first screen. Select one project or use the **Menu/New Project**. The following functions for managing projects are also enabled (**Menu** button).

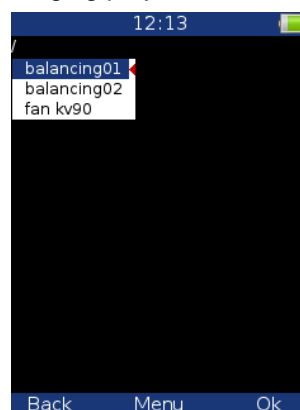

### ***New Project***

You have to enter new name of the project when you choose this item.

### ***Copy Project***

This option creates new project as a copy of the selected one. No data are saved to new project, only balancer settings are copied.

### ***Rename Project***

You can rename the selected project with this option.

### ***Delete Project***

You delete the selected project.

### ***Clear Project Data***

It erases all measured data. Only project with balancer settings remains in device.

## ***New project***

Press the **Menu** button and select the **New Project** item. Enter the name of the project. The new project is added to the list of projects and it is selected (active in dark colour). Press **OK** (F3) to open the project. The list of settings appears. Define your balancer settings and press **OK** (F3).

## ***Balancer Menu***

### ***Balancer Settings, Units Settings, Rotor Settings***

Open settings menu for current project. Will be described later.

### ***Enter Trial***

For trial runs only. Enter the value of the trial mass.

### ***Enter Values***

You can manually enter the values instead of measuring them (balancing calculator function).

### ***Enter DF***

For trial runs only. You can enter a dynamic factor of balanced rotor instead of processing the trial run. The value of the dynamic factor is always calculated after the trial run and can be displayed using **Menu/Display DF**. If you balance the same rotor after some time, then there is no need to measure the trial run again. Instead, you can enter DFA (Dynamic Factor Amplitude) and DFP (Dynamic Factor Phase) values.

### ***Display DF***

For trial runs only. If the dynamic factor is not entered manually, but is calculated during balancing from the values of the measured or entered vibrations, then it is not displayed on the screen. You can display it using this menu item.

### ***Report***

The function creates a balancing report in .rtf format (MS Word) and saves it to the VA3\_DISC (directory va3/report) for PC downloading.

### Vector

This shows the drawing of amplitude/phase vector development during the balancing process. The drawing is also included in the balancing report.

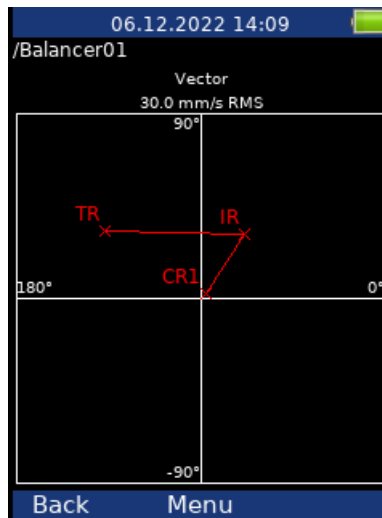

Description: IR – Initial Run, TR – Trial Run, CR – Correction Run.

### Total Mass

Displays the total balancing mass. It is a vector sum of all masses mounted to the rotor (all correction weights and kept trial weights).

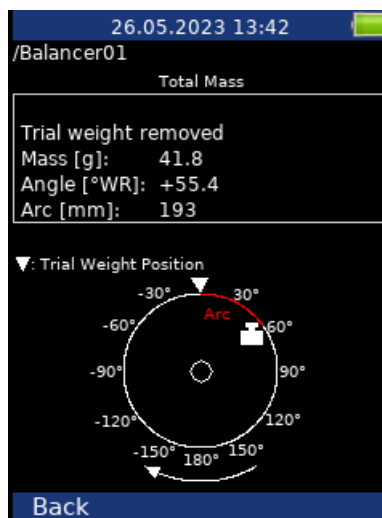

**Note!** For dual plane balancing, use *Left / Right* arrows to switch between planes.

## Balancer Settings

Press **F2** for **Menu** and select **Balancer Settings**. All project properties are defined here as follows

### Planes

single, dual (plane(s) balancing)

### Image

selection of machine image (for single plane balancing only)

inside rotor

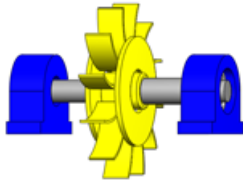

overhung rotor

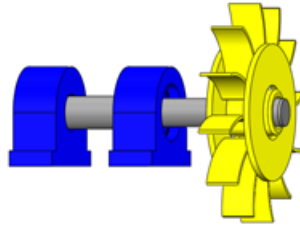

**Look**

view direction  
left

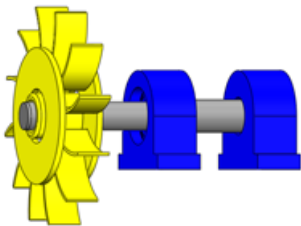

right

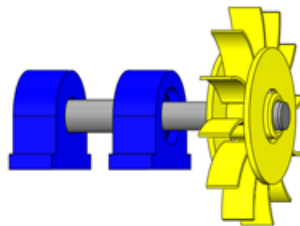

**Rotation**

**CW** (clockwise), **CCW** (counterclockwise)

**Point A**

1-3 (the number of AC input which will be used for sensor mounted on point A)

**Point B**

1-3 (the number of AC input which will be used for sensor mounted on point B)

**Note!** You can enter the same AC channel number for both A and B point. In this case, the measurement with one sensor is expected and readings for both points are not taken together. First, you take the measurement on one point. Then, you remount the sensor to the other point and take next reading. The point, which is currently measured is selected by **Up / Down** button (see later).

| /Balancer02           |       |
|-----------------------|-------|
| Initial Run           |       |
| Point A               | done  |
| Amplitude [mm/s RMS]: | 11.9  |
| Phase [°WR]:          | -89.0 |
| Speed [RPM]:          | 3001  |
| Point B               | done  |
| Amplitude [mm/s RMS]: | 9.94  |
| Phase [°WR]:          | -12.0 |
| Speed [RPM]:          | 3001  |

| /Balancer02           |       |
|-----------------------|-------|
| Initial Run           |       |
| Point A               | done  |
| Amplitude [mm/s RMS]: | 11.9  |
| Phase [°WR]:          | -89.0 |
| Speed [RPM]:          | 3001  |
| Point B               | done  |
| Amplitude [mm/s RMS]: | 9.94  |
| Phase [°WR]:          | -12.0 |
| Speed [RPM]:          | 3001  |

**Note!** The point markings A and B have only a symbolic sense. They have no relation to the balancing planes 1 and 2 and to the balancing computational procedure. You can mark any measuring point as A and the second as B.

**Remove Trial Weight**

**yes, no** (the trial weight can be left on the rotor or it can be removed after trial run)

**Remove Trial Weight (Plane 1), Remove Trial Weight (Plane 2)**

**yes, no** (for 2 planes balancing, you may remove or keep trial on each plane individually)

## **Correction Weights**

add (mount), remove (drill)

### **Components**

Number of components. This parameter is used in job requiring the split of the correction weight into components (blades for example).

### **Meas Mode**

**single, online meter:** When you start a measurement process by pushing *Start*, then only one value can be taken (**single**) or the continual measurement values could be displayed (**online meter**). In **online meter** mode, you may look at more values and to evaluate the changing of them in time. You need to stop the measurement by pushing *Stop*, when is displayed the value, which you want to use.

### **Avg**

The averaging of more than one measured value is available

### **Resolution**

It's the aps measurement resolution described in Analyzer / New Meas / New Meas (Advanced) / Resolution.

## **Units Settings**

Press **F2 for Menu** and select **Units Settings**. Set the units for current project.

### **Amplitude**

Selection from available vibration units.

### **Detect Type**

**RMS, 0-P, P-P**

**Note!** This value is same as global value defined in Global / Detect Type until you change it here. That means, if you change the global value, it will be changed here also. This will stop after the first time you enter a value here.

### **Speed, Mass, ...**

Selection from available units for particular quantity.

## **Rotor Settings**

Press **F2 for Menu** and select **Rotor Settings**. All parameters are optional. It enables to calculate unbalance and balancing quality factor according to ISO1940.

### **Operating Speed**

One of the parameters used for Quality Grade calculation is the speed of the rotor. By default, the Quality Grade calculation uses the speed detected during the balancing process. However, sometimes the real operating speed differs from the balancing speed. In this case, you can enter the operating speed here and this speed will be used for Quality Grade calculation.

### **Rotor mass**

Rotor mass in mass unit

### **Correction Radius**

Radius to which the balancing mass will be mounted (could be different for each plane).

### **Quality Grade**

Demanded quality grade according to *ISO 1940*, if entered, the recommended trial can be computed.

## **Single plane balancing**

### **Initial Run**

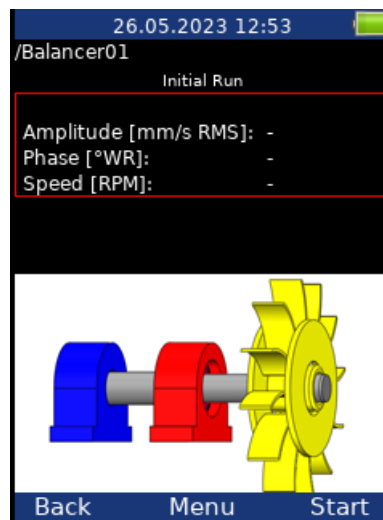

The red bearing house is the recommended point for sensor mounting. But you can use any other place, which is suitable for measurements.

Push **Start** button to start the measurement process. Alternatively, you may enter the values using Balancer menu / Enter Values (balancing calculator function).

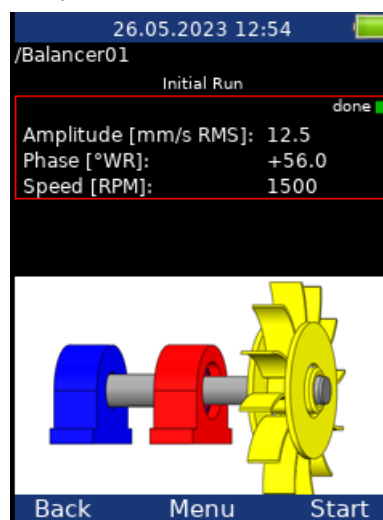

Press the **Right** arrow to move to the next screen.

### **Trial Run**

The trial weight response is measured in this run.

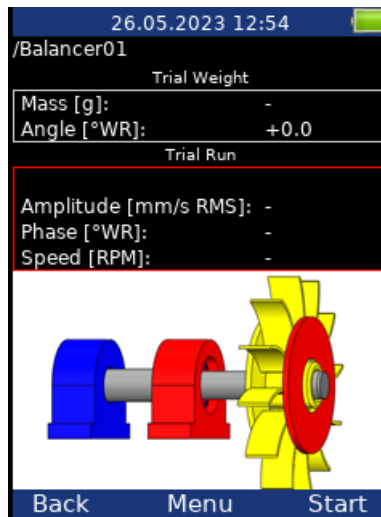

Use the Balancer menu / Enter Trial and enter the mass and angle of the trial weight. Usually, the trial weight is placed at zero angle and serves as a zero mark. However, you can set the zero mark wherever and set the trial weight angle from the zero mark. The angle of the trial weight must keep the Global / Angles Counting setup. This means, if you use **with rotation** angles counting, the angle is positive when you put the trial weight before the zero mark in the direction of rotation and negative when you put the trial weight behind the zero mark (or when the trial goes first and zero mark goes second the trial weight angle is positive). For **against rotation** angles counting, it is the opposite.

If the Balancer Settings / Components have been defined, the trial weight position is entered as the number of the component. The angles counting must be kept as well. The component number grows in the direction of rotation if with rotation is set and vice versa.

The mass can be negative, it represents removing of the weight (for example dismounting of old correction weight).

The recommended weight value is displayed only if the Rotor Settings parameters are entered.

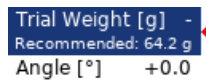

Don't forget to mount the trial weight to the balancing plane.

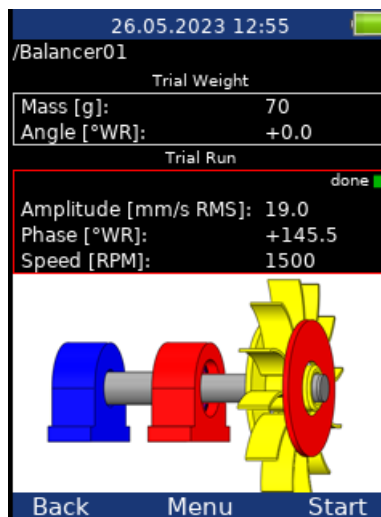

After the trial run measurement, the **dynamic factor** of the machine is available (Balancer menu / Display DF).

DFA 324  
DFP [°] 179

The **DFA** and **DFP** (amplitude and phase) values are the response values of standardized trial mass on the correction radius. If you will balance the same machine again after some time, then you do not need to measure the trial weight response again. Instead, you may just enter the **DFA**, **DFP** values on this screen. Use Balancer menu / Enter DF for that.



If you have entered Correction Radius and Rotor Mass values in the Rotor Settings menu, the **Initial Unbalance** and **Balancer Quality** values according to *ISO 1940* are displayed on next screen. In case the values are satisfactory, you don't need to continue with the balancing job.



**Note!** The initial means that trial weight is not taking account, even if it is kept.

## Result

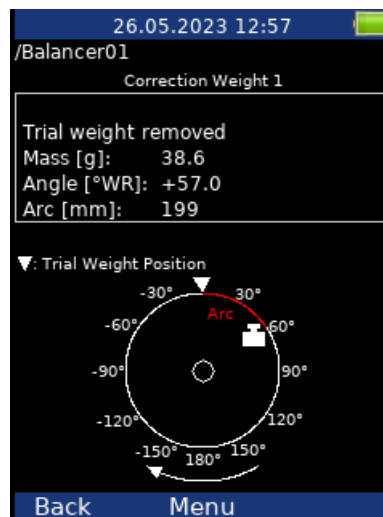

According to the Balancer Settings / Remove Trial Weight, the information window appears.

**Remove trial weight!**

or

**Keep trial weight!**

Don't forget to remove the trial weight if it is set. However, you can use it as zero mark first and remove it after correction weight mounting.

The weight and angle (position) of the correction weight are displayed.

The angles are calculated from the zero mark. The direction of the angle depends on the Global / Angles Counting value. If it is set as **with rotation**, the angle direction is same as the direction of rotation and positive values are in the direction of rotation (in the picture above it is +57° in the direction of rotation). The direction of rotation is shown by the arrow below. If the Angles Counting value is set as **against rotation**, the angles have opposite values.

With rotation:

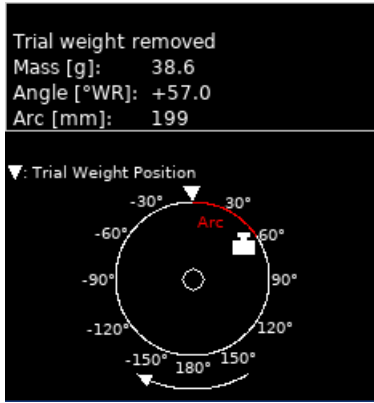

Against rotation:



**Warning!** If you haven't defined the direction of rotation, the result is displayed in default direction with angles increasing counter clock wise. The angle has still the same value (+57° with rotation or -57° against rotation). However, the picture may not correspond the reality. You need to determine the right position yourself.

With rotation:

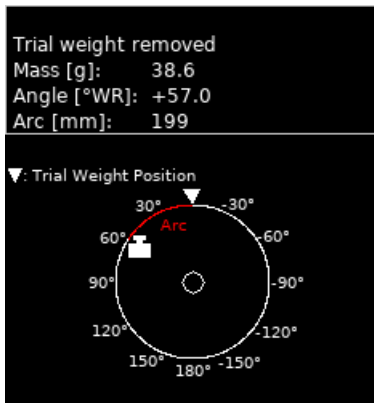

Against rotation:

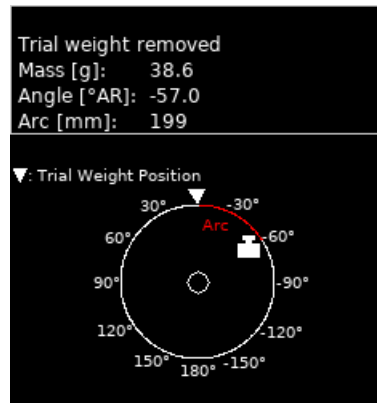

**Note!** You cannot change the Angles Counting value during a balancer job. If the value is changed, the error message appears.

**Error**  
 Angles counting in project is different from settings in instrument.  
 Change the value in menu Global / Angles Counting or create new project.

In case you have entered the Correction Radius value, the **Arc** value shows a circumferential distance of the correction weight from zero mark.

You can split correction mass to two arbitrary angles (in case if it is not possible to place the correction mass into calculated position). Go to menu **Menu / Split correction weight**

Enter the value of the first angle.

123

Enter first angle

Then enter the value of the second angle.

123

Enter second angle

The balancing mass will be recalculated (split) into two required angles.

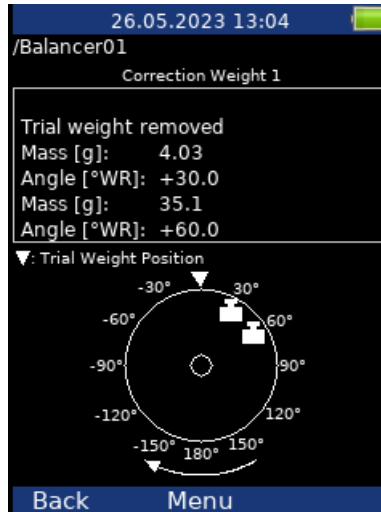

Use **Menu / Set Default Angle** to return back to the original calculation.

If the Components have been defined, the correction weight is divided between two nearest components. The component number is counted from the zero mark, which is the component number one. The component numbers keep the angles counting parameter. The component number grows in the direction of rotation if with rotation is set and vice versa.

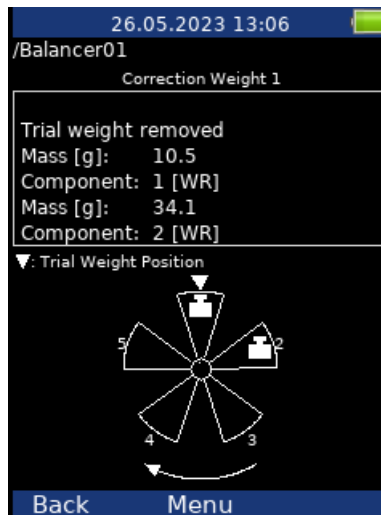

You can select other components in case when you cannot mount weight to the nearest components. Select **Menu / Change Components** menu item.

Enter the number of the first component.



Then enter the number of the second component.



New correction weights will be displayed.

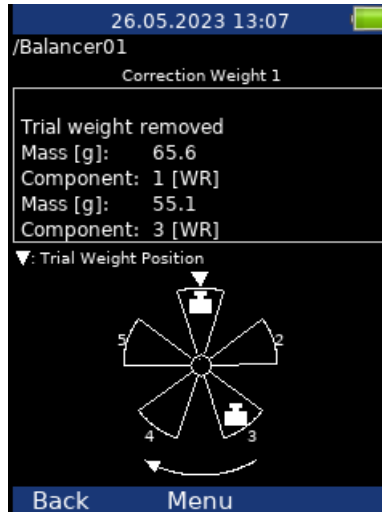

Select **Menu / Set default components** menu item to return to the original weights.

Mount the recommended correction weight to the machine.

### Correction Run

When the weight is mounted you want to check the job.

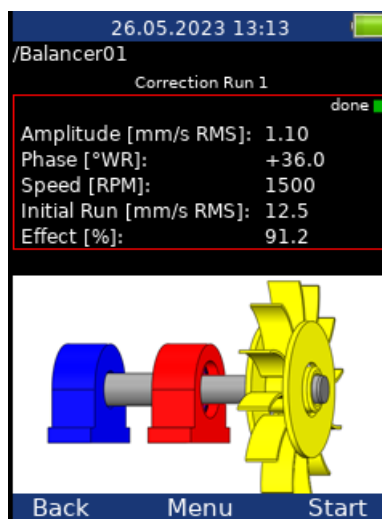

- **Initial Run**  
amplitude of Initial Run
- **Effect**  
is the reduction of balancing in %  
 $Effect = (1 - A2 / A1) * 100\%$   
(the 1.1mm/s is the 8.8% of 12.5 mm/s)

Residual unbalance and quality and next correction weight suggestion are available on next screens.



You can continue with the job until you are not satisfied with the results. These next steps do not require trial weight measurement already. After each measurement the next correction weight is recommended. However, when the result is not better (or even is worse) the next correction runs have no sense.

## Dual plane balancing

### Initial Run

The screen is divided into two parts. The upper part corresponds to **Point A** and the lower one to **Point B**. If you use only one sensor, then only one part is selected (red border). The other part is bordered in grey. Mount the sensor to the selected point and take the reading. Use the **Up / Down** arrow buttons to change the selection of the point. Do the same for the second point. With two sensors you take both points readings at once.

You can also enter the values manually.

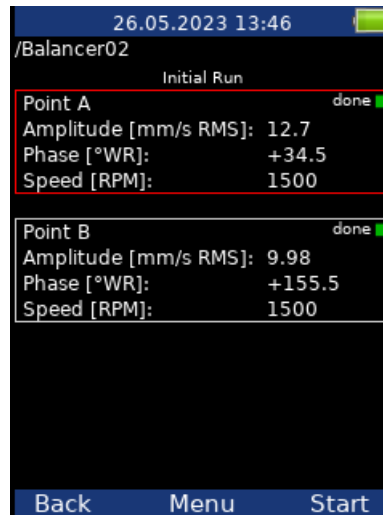

### Trial Run 1

It is similar like single plane balancing, only two trial weights must be subsequently mounted to two planes. If you know the *dynamic factor*, then you can enter all 4 values manually and you do not need to measure trial runs. See more details about dynamic factor in Single plane balancing / Trial Run.

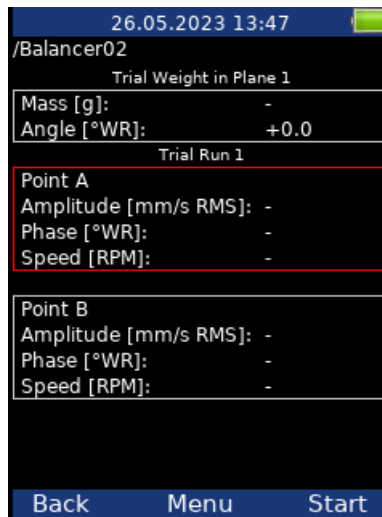

See the Single plane balancing / Trial Run for more details about trial weight mounting. Put the trial weight to the plane 1 and take the measurements for both points.

After both points measurements are taken, you should resolve the trial weight according to the Balancer Settings / Remove Trial Weight (Plane 1).

In case of Remove Trial Weight is set as **yes**, next question will appear:

Temporarily keep trial weight in plane 1 also during measurement with trial weight in plane 2?

If you answer *No*, then you must remove the trial weight as expected. However, you can answer *Yes* and keep the trial weight on plane 1 also during measurement with trial weight in plane 2. This can be useful, when you want to use the trial weight as the zero mark for correction weights mounting.

In case of Remove Trial Weight is set as **no**, next notification will appear.

Keep trial weight in plane 1!

After confirming a message, you can check the measured values on the Trial Run 1 screen.

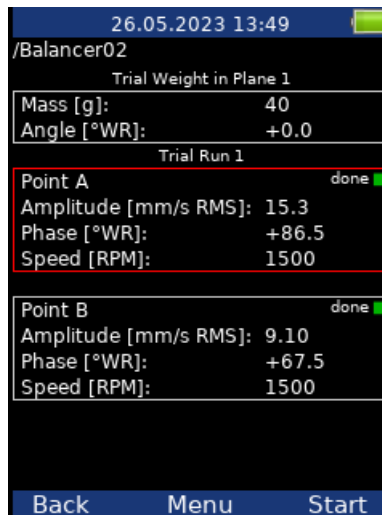

## Trial Run 2

The same two measurements we have to take with trial weight in plane 2. The screen for those measurement looks similarly like previous screen. Only the red disc is in the plane 2. Enter the trial weight values and put the trial weight into the plane 2. Take the measurement on both points.

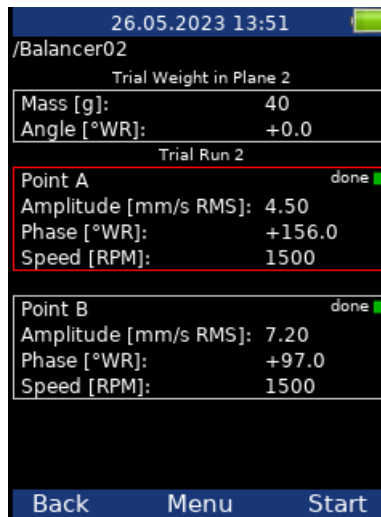

### Result

After entering the result screen, you will be notified to keep or remove the trial weight from the plane 2 according to Balancer Settings / Remove Trial Weight (Plane 2). In case you temporarily kept the trial weight, you'll be also notified to remove it now.

Remove trial weight from plane 1!  
Remove trial weight from plane 2!

Don't forget to remove the trial weights if needed. However, you can use them as zero mark first and remove them after correction weights mounting.

The result screens look similar like for single plane balancing. They contain correction weights suggestion for both planes. See more details about correction weights mounting in Single plane balancing / Result. The initial and residual unbalances and qualities are calculated for the whole machine, not for each plane separately.



### Correction Run

See Single plane balancing / Correction Run for more details.

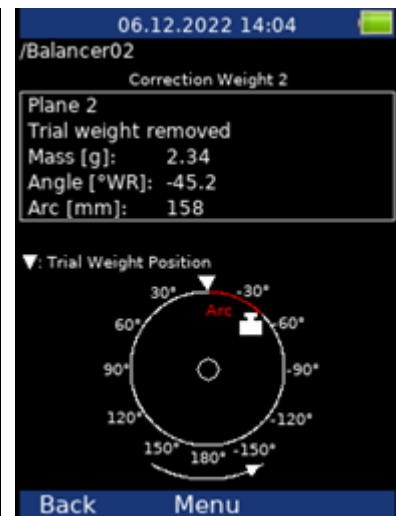
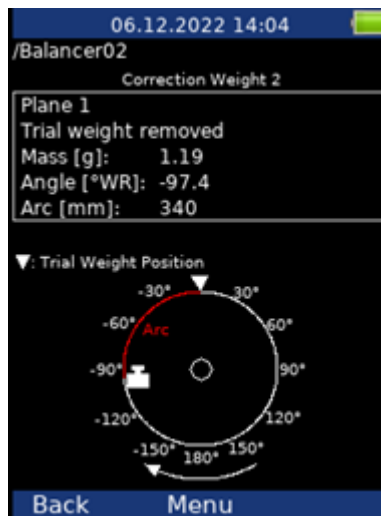
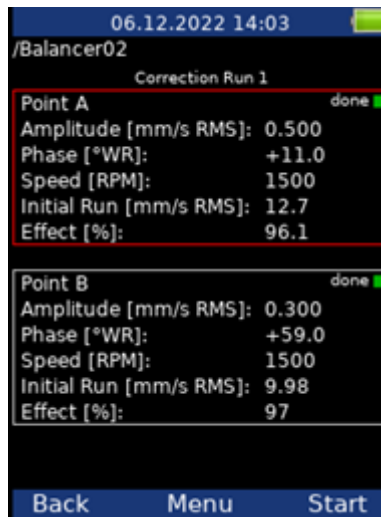

### Balancing errors

Balancing errors and warnings can occur during the job.

#### The effect of trial weight is low

This message informs you that the effect of the trial weight is low.

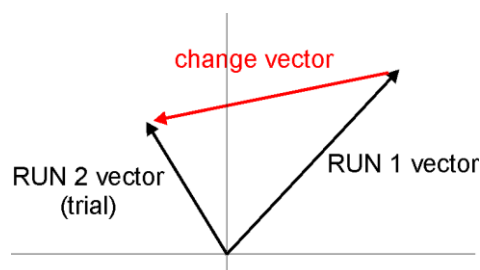

The percentual value is derived from ratio (amplitude of change vector/ amplitude of Run1 vector).

A warning is displayed when the change is less than 20% but bigger than 1%. You can continue with balancing after this warning and use these values.

An error is displayed when the change is less than 1%. You cannot continue with balancing after this error, because such a small change is not acceptable. You could get incorrect results.



***Unacceptable speed change***

The balancing procedure must be executed on constant speed during all runs. The balancing speed is checked and when it changes more than 5 % the error occurs.

***Unstable phase***

The phase stability can be checked only if the averaging is used (Balancer Settings / Avg). If the phase during averaging changes, this probably means the unbalance is not the main problem of the machine. Thus, the error is indicated and the balancing procedure stops.

## **Recorder**

Some of you maybe remember that in the past a signal was recorded to a tape-recorder and afterwards it was processed (analyzed) in an analyzer. This method had a huge advantage; the signal could be analyzed repeatedly over and over. If you wish to make all the requested analyses in real time, you are under time pressure. For example, the runup of the machine can be run only once, you are under extreme pressure. The tape-recorder was an excellent solution for those cases. It is a simple unit with a simple operation and no danger of losing the data.

The recorder module offers the same solution. The recorder module enables you to record the raw signal from the sensor without any post-processing or filtering.

It enables you to record all the channels (3 AC channels, 3 DC channels and a tachometer / external channel) to the memory of the VA3 unit simultaneously. The sampling frequency is from 64 Hz to 196608 Hz. The record is saved in the memory and you can analyze it later according to your requirements.

### ***Record length***

Record length is limited. Limit is 1000 MB of data – it is 81 minutes of record from 1 AC channel with a sampling frequency of 65536 Hz.

### ***Record screen***

The first screen of the recorder module shows the list of saved projects or an empty list. **Menu** is at the bottom (F2).

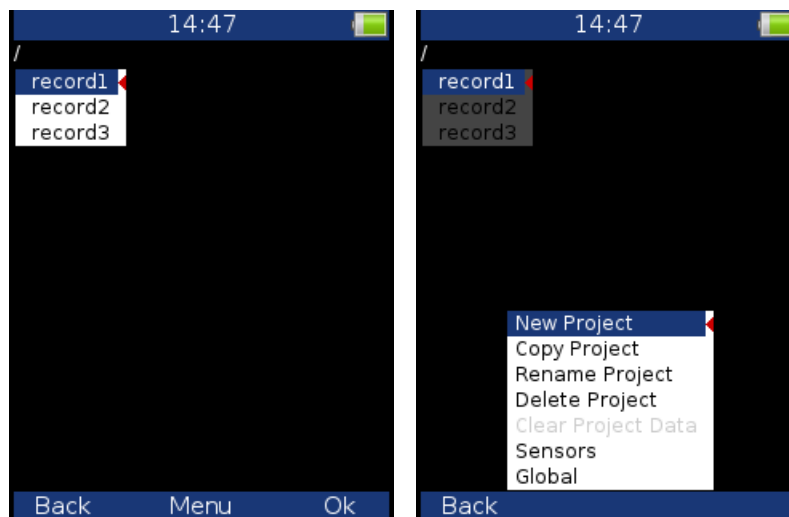

#### ***New Project***

This creates a new project. Enter the name of the project and confirm by pressing **OK**.

#### ***Copy Project***

This creates a new project with the same settings as the selected project. Enter the name of the new project and confirm by pressing **OK**.

**Note!** Only project settings are copied, no measured data are copied.

#### ***Rename Project***

This function renames the selected project. Enter the new name and confirm by pressing **OK**.

#### ***Delete Project***

Delete the selected project.

### **Clear Project Data**

Delete the measured data in the project.

### **Project screen**

Select the required project and press OK. If the selected project contains measured data, the record preview is shown. If there are no measured data, the record project settings appear.

### **Record settings**

Press **F2** for **Menu** and select **Record Settings**.

#### **Sampling frequency Fs**

Record sampling frequency (maximum **65536** Hz). The record frequency range is shown below Fs.

#### **AC1 – AC3**

Switches required AC channels – on/off.

#### **DC1 – DC3**

Switches required DC channels on/off.

#### **Tacho / External**

Switch this on if you wish to record the Tacho / External channel.

#### **Length**

You can set up the required record length. You can enter the required length in minutes or seconds. If you select the option Manually stopped, the record will be stopped when you press the **Stop** button or when the available memory is full.

The available space is displayed below – the available space in memory (MB) and possible record length (hh:mm:ss).

If the entered length exceeds the 1000 MB limit, it will be shortened automatically. The message **Required length shortened!** appears in this case.

#### **Start of Rec**

More options available.

**freerun**: recording starts immediately after pressing **F3** (start) button,

**external**: recording starts when the signal appears in Tacho / External channel,

**amplitude**: recording starts when the signal from the Tacho / External channel exceeds the amplitude trigger level (see **Ampl Trig Level** below).

#### **Pretrig**

You can enter the length of the record before the trigger (enter it in seconds or minutes).

#### **Ampl Trig Level**

It is trigger level set in sensors units. You can enter positive (rising edge) or negative (falling edge) level value. The signal amplitude is taken directly from the sensor input (it means, that no additional filtering is applied). For better understanding see following example:

**The level is set to 1 g** – triggered when the *rising* signal exceed 1 g.

**The level is set to -1 g** – triggered when the *falling* signal drops below -1 g.

## ***Ampl Trig Channel***

The number of the channel used for amplitude triggering.

## ***Sensor settings***

Settings for sensors are in **Menu – Sensors**. You set there parameters for sensors which you are going to use. The sensor settings will be saved in the project.

## ***Recording***

Recording is started with pressing **Start (F3)** button. On the other hand, recording is stopped when one of the following states appears:

- The set-up time is over,
- Stop button is pressed,
- 1000 MB limit is reached,
- No free space in memory has left.

When the recording is on, the currently measured value is displayed next to the corresponding channel or there is information about ICP error and overload. There is the preview of the record of one AC channel at the bottom; you can switch between the preview of the recorded channels by pressing the up/down arrow buttons. There is information about the available memory and remaining signal length displayed at the top. The remaining signal time length is displayed in the format: hh:mm:ss.

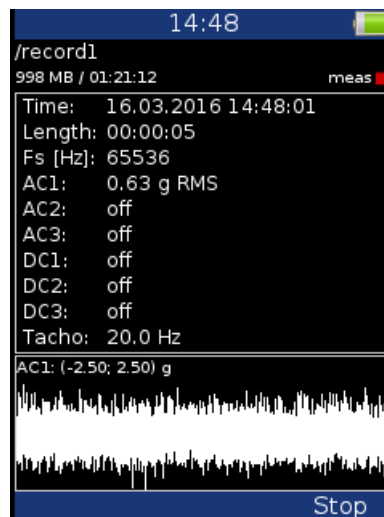

## ***Preview of recorded data***

After the recording, the preview of measured data is displayed. The setting of each channel is also displayed. In the graph there is a preview of the record from 1 channel. You can change the displayed channel by pressing the up/down arrow buttons.

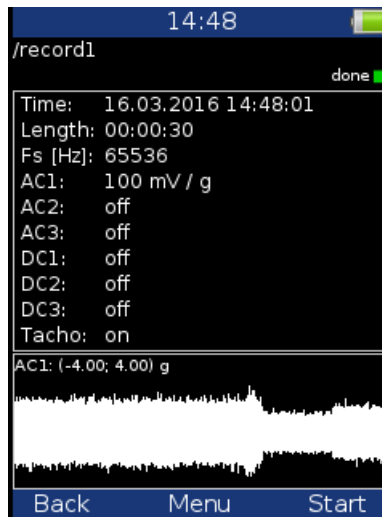

### ***Record analysis***

For record analysis you need to use the A4410 Virtual Unit application. The A4410 Virtual Unit application can be downloaded from the Adash website for free:

[http://www.adash.com/downloads\\_software\\_adash.php](http://www.adash.com/downloads_software_adash.php)

Download the Virtual Unit application to the PC and you can analyze the signal in for example Analyzer module. For more information see the A4400 VA4 manual, which describes the functions of the Virtual Unit.

# Run Up

Next VA3 module is run up module. You can see more details in this chapter.

## Measurement control

When you need to measure Run Up or Coast Down of the machines, then you should use the **Runup** module. It enables the same measurements as in **Analyzer** module. BUT the measurement is controlled by speed, time or it can be uncontrolled.

What does it mean "controlled"? In Analyzer module you can measure the Set and then you have to save measurements manually.

The **runup** module is different. The measurements are saved automatically and additionally the measurements are regularly repeated under the control. The trigger is used for this control. The menu item **Menu – Trigger – Runup mode** is used for setting.

Usually, **the speed** is used for that control and new measurement is made, when the speed changes from the previous measurement of the defined value (e.g., 10 RPM).

Also, **the time** can be used to control this procedure. Then you can take the measurement in defined time interval (e.g., each 60 seconds).

The **asap** is the next choice. This option means no delay between the measurements – **As Soon As Possible**. You need to be careful with this mode. You can use all memory of device quickly.

The last choice is the **Manual** mode. You can press the Ok button at any suitable moment to make a new measurement.

Available interval is displayed on the status bar before the measurement is started. The device enables to save up to **1 GB of data** (on each measurement – if enough memory is available). **BUT** the limit of 1 million values per SET cannot be exceeded.



## Measurement setting

Measurements are defined in sets. Use sets the same way as described for analyzer module. See example below. We define only one measurement in set. The proximity sensor on channel 1 is used.

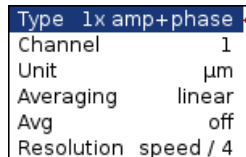

The **Runup mode** is set to **speed** and the value is 1Hz.

## Measurement

Start measurement – press **Start** button. After the final speed is achieved press **Stop**.

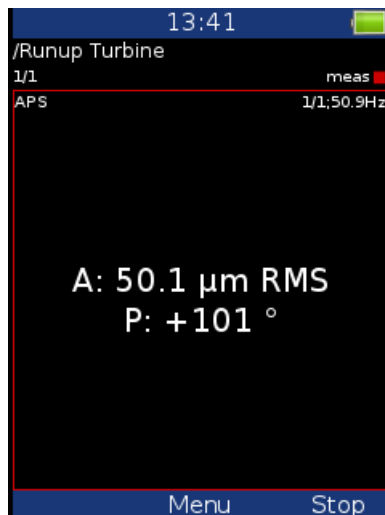

The last measured value is shown on the screen.

## Trends

Use **Menu – View Trend** to display the list of measured trends. Every new measurement creates new item in this list. The date and time of the measurement is displayed.

```
01.11.2009 12:31:08
02.11.2009 16:32:55
03.11.2009 15:32:14
04.11.2009 19:08:13
```

Select one trend from this list and confirm it with **OK**. The trend is loaded and displayed.

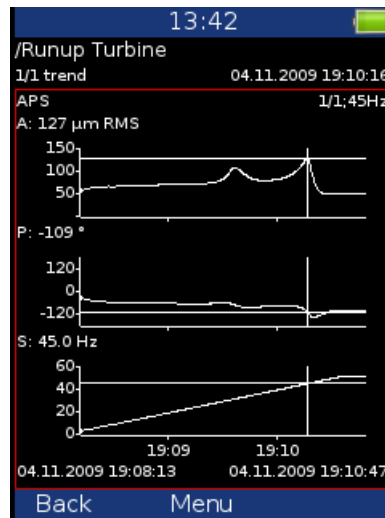

Use the **Shift** button (button with number **1**) to change function of arrow buttons. Set the arrow buttons to trend. Use left and right arrow buttons to change the cursors position.



## Delete trends

When the trend is displayed, use **Delete** button in **Menu** to delete the selected trend.

# Ultrasound

We would like to explain a few terms in the beginning. Higher frequency energy above 20 kHz is best detected with an ultrasonic sensor. The most useful information is found in range between 30 and 50 kHz. Adash **Ultrasound** module enables monitoring of ultrasonic energy.

Ultrasound utilizes a solid, liquid or gas to transmit (it will not exist in a vacuum). It is a very directional and short waveform. It has several things in common with the vibration, for instance the ability to detect the ultrasound energy requires the sensor to be focused in the direction of the waveforms.

Field applications for airborne ultrasound detection:

- consider the wave energy is easily reflected and attenuated,
- when looking to detect airborne ultrasound energy a rule of half distance twice amplitude is a good thing to consider, this is called the “inverse rule”,
- remember airborne ultrasound is easily reflected, when detecting a leak, you should turn in the other direction to determine if the sound is coming from behind you,
- use shields such as cardboard to isolate the potential defect from other sources.

## Sensor setting

The ultrasound measurement is available only on **AC CH1**. You need the ultrasound microphone for that. When you run the module, then the sensor is changed automatically to Pascal sensor.



Go to **Menu – Sensors – AC1** to change the sensitivity if needed. The new setting is saved and used in next run. The original sensor is set when you leave the module.

## Settings

You can set the range of the measurement. Go to **Menu – Ultrasound settings**. Enter required range.



## Measurement

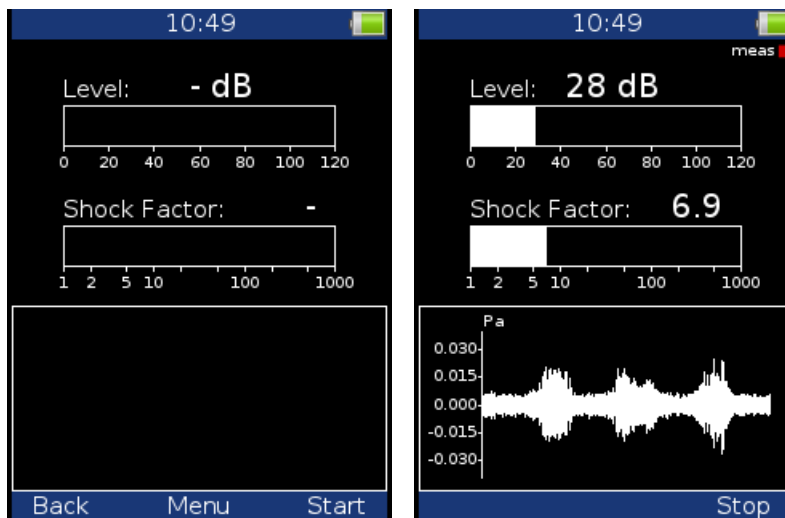

Press **Start** button. Two values are displayed. The **Level** of sound in dB and **Shock Factor**. The Shock factor is defined as Peak value divide by RMS value. It means value 1.4 for pure sine. Higher values means that transient shock events are in the sound signal.

The time waveform is displayed at the bottom of the screen. Use **arrow up button** to fit the scale of the graph. Press **Stop** to stop the reading.



## **Appendix A: Technical specifications**

### **Inputs**

|                              |   |
|------------------------------|---|
| Input channels:              | 3 AC, ICP® power supply on/off<br>3 DC for process values<br>1 TACHO for external trigger   |
| Input range:                 | AC +/- 12 V peak-peak<br>DC +/- 24V   |
| AD conversion:               | 24 bit, 64 bit internal signal processing<br>AutoGain function is not necessary!  |
| Dynamic range S/N:           | 120 dB  |
| Frequency ranges (-3 dB):    | Maximum range: 0.5 Hz - 25 kHz (64 kHz sampling)<br>Minimum range: 0.5 Hz - 25 Hz (64 Hz sampling)  |
| Sampling mode:               | Fully simultaneous for 3 channels   |
| FFT resolution:              | Min. 25 lines<br>Max. 25 600 lines  |
| Unit modes:                  | Analyzer - analytic measurement<br>Data collector - route measurement<br>Balancer<br>Recorder<br>Run Up<br>Ultrasound<br>LED stroboscope, LED torch<br>FASIT - Expert system for fault detection<br>Vibration meter |
| Data processing:             | Real time FFT<br>DEMOD - ENVELOPE analysis<br>ACMT - low speed bearing analysis<br>Order analysis<br>User band pass analysis<br>RPM measurement<br>DC measurement<br>Orbit measurement                              |
| IR temperature measurement:  | Range -70°C to +380°C (-94°F to +716°F)   |
| Trigger:                     | Manual, External, Amplitude, Tacho - Ex ia op is IIC T4 Ga  |
| Display:                     | Colour 240 x 320 pixels, TFT  |
| Communication:               | USB   |
| Operating temperature range: | -10°C to +50°C (with tacho probe +40°C)   |
| Power:                       | Battery 6 hours of operation, AC 100 V - 230 V  |
| Case:                        | Aluminium heavy duty  |
| Weight:                      | 760 g   |
| Dimensions:                  | 230 x 82 x 32 mm  |

## **Appendix B: Vibration standards**

Using standards is a frequent topic in vibration diagnostics. As there are a lot of different types of machines it is impossible to determine the critical limits of vibrations for a wide range of machines. Its reliability would be then low. It could happen that you would repair a machine unnecessarily. The standards should rather be determined for a narrow range of machines.

### **Adash Limit Values**

Adash limits are not rewritten from any existing standard. It is a result of more than 20 years of the **Adash engineering team's experience**. It is difficult to invent a critical value definition which would be simple (which means not many parameters such as speed, power, bearing type, machine type and so on) and reliable.

In the figures below you can see how to derive Adash limit values. There are three levels of machine condition defined:

**GOOD,**

**ALERT** (Machines that lay in this range are not acceptable for a long period of operation, they can be operated until time when they can be repaired),

**DANGER** (Vibration values in this range are considered as very dangerous and machines should not be operated).

The corresponding colors are taken from traffic lights - green, yellow and red.

All limit values are related to the speed value. Low speed machines should generate lower vibration than higher speed machines.

You can find three particular areas in the graphs below. The GOOD condition is the area up to the yellow line which means operation without restriction. The area above the yellow line and under the red line is the ALERT condition. It is possible to operate the machine but it has to be checked more frequently and it is necessary to determine the source of the worse condition and plan the repair (for instance change the bearing) or maintenance (balancing, alignment). The area above the red line is the DANGER condition and the machine should not be operated. The first figure contains the values for overall machine condition. The value of overall machine condition can determine unbalance, misalignment or mechanical looseness. They are called "overall" because we can measure them on most of the measuring points on the machine. The second figure contains the limit values of roller bearing condition. This condition is local and can be measured only on the appropriate bearing house.

It is easy to understand the graphs below. It is necessary to know the speed. The instrument (A4900) determines the speed automatically or it can be entered manually by the user. Look at the graph and find the point on the horizontal axis which corresponds to the speed. You will find an intersection with the yellow and red lines above this point. Projections to the vertical axis will determine limit values for yellow (ALERT) or red (DANGER) states. If the measured value is lower than the yellow value the condition is GOOD – green. If the value is above the yellow value and under the red value then the condition is ALERT – yellow. If the measured value is higher than the red value then the condition is DANGER – red.

**Adash Limit Values of Machine Vibrations**

The machine limits are used for velocity RMS value in 10-1000Hz frequency range.

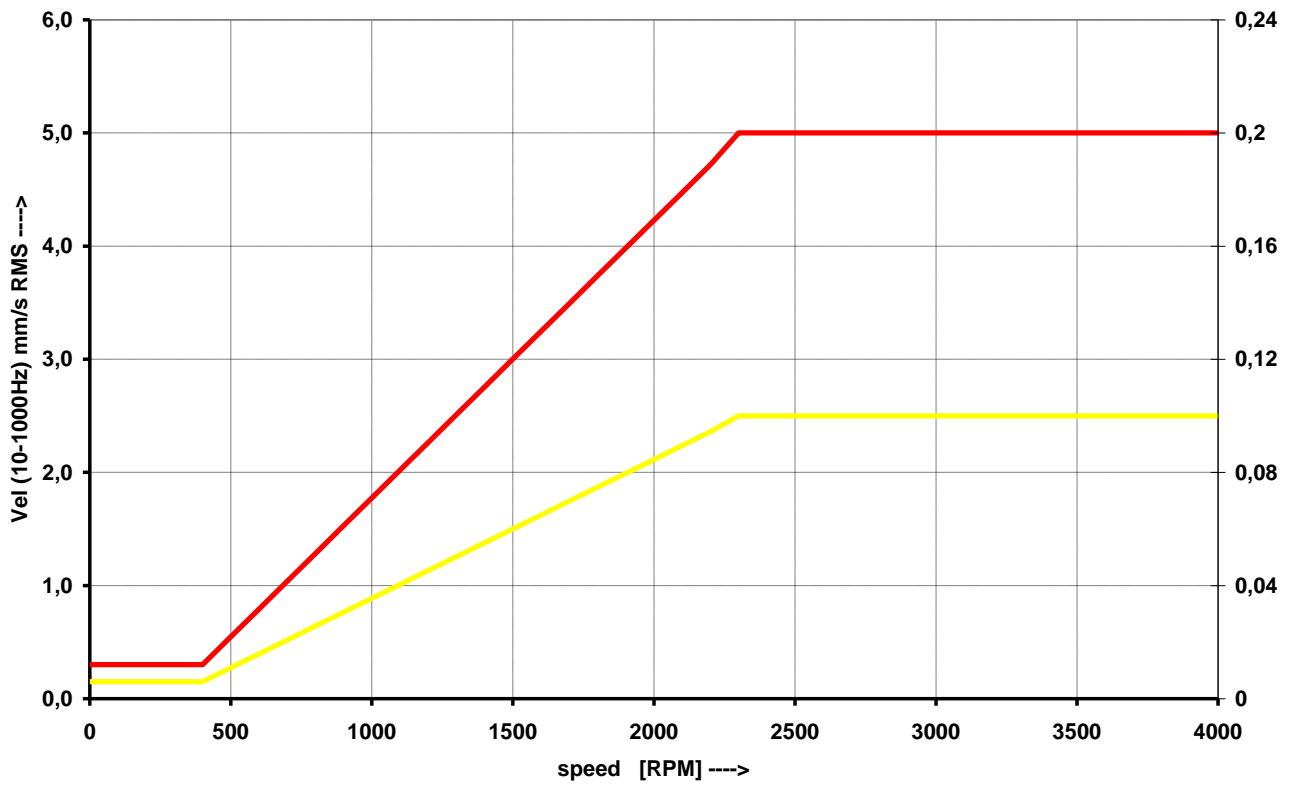

**Adash Limit Values of Bearing Vibrations**

The roller bearing limits are used for acceleration RMS value in 500-25600Hz frequency range.

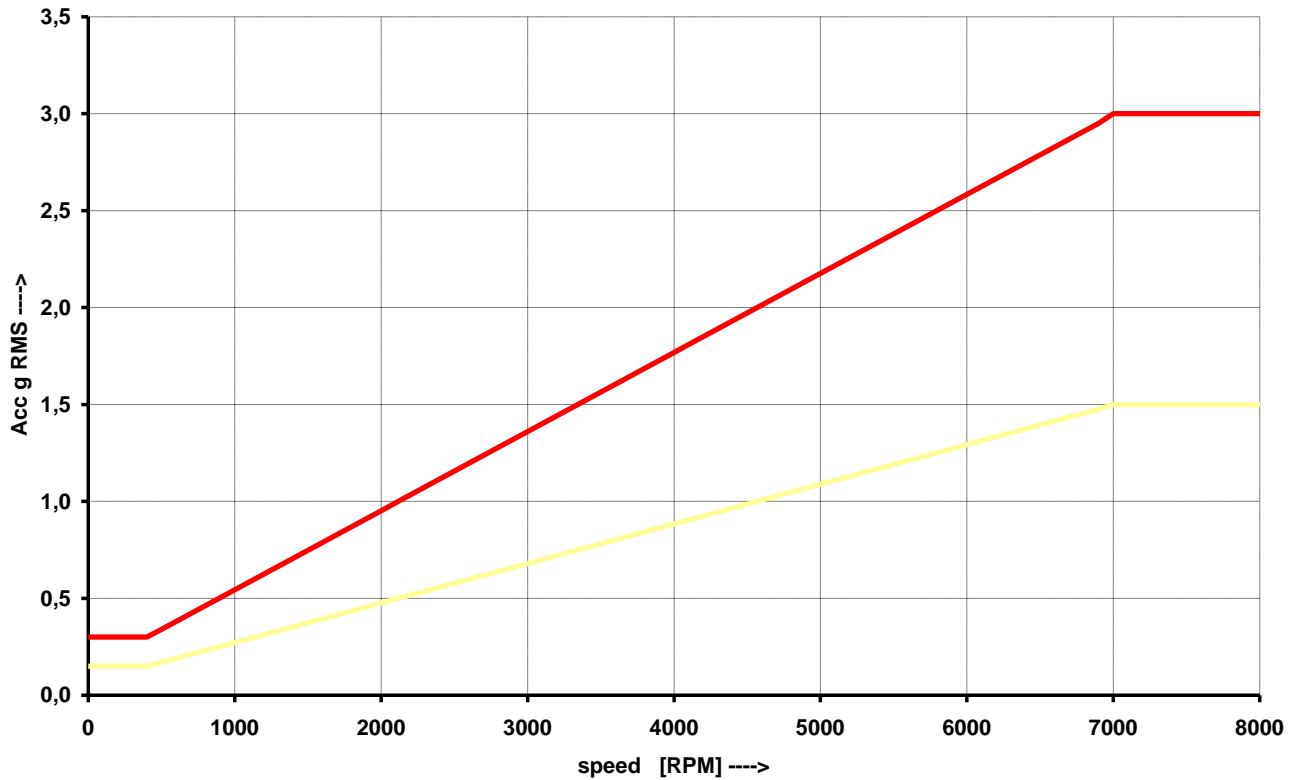

## **ISO 10816/20816 limit values**

There is a wide range of valid standards but we would like to mention ISO 10816/ISO 20816. It has several sections and it also deals with procedures of obtaining limit values for particular machines. It contains 3 tables of values, which are applicable for the A4300 – VA3Pro unit.

### ***Classification according to machine type, nominal power or shaft height***

Select the group which best describes the general size, type, and speed of the machinery being measured. Note that these machine group classifications are set according to ISO 10816-3, which rates overall velocity vibration levels for industrial machines with rated power above 15kW and nominal speeds between 120 RPM and 15000 RPM when measured on site.

### ***ISO Groups 1-4 classifications define the following types of machinery:***

#### **Group 1**

Large machines (rated power above 300kW) with a shaft height greater than 315 mm. These machines are normally equipped with sleeve bearings.

#### **Group 2**

Medium-size machines (rated power from 15 kW to 300 kW) and electrical machines with a shaft height between 160 and 315 mm.

These machines are normally equipped with rolling element bearings.

#### **Group 3**

Pumps with multi-vane impeller and with separate driver with rated power above 15 kW.

#### **Group 4**

Pumps with multi-vane impeller and with integrated driver with rated power above 15 kW.

### ***Classification according to foundation***

An additional setting allows the specification (when defining the overall alarm levels) of measurements taken from machinery with Rigid or Flexible foundations.

### ***Evaluation ranges***

The following evaluation ranges are defined for evaluation of the machine health according to vibrations:

**Range A:** New machine vibrations should be occasionally in this range.

**Range B:** Machines in this range can be operated for unlimited period.

**Range C:** Machines in this range are not acceptable for a long period of operation; they can be operated until the repair time only.

**Range D:** Machines with vibration values in this range should not be operated. There is an acute danger of damage to the machine.

**Classification of vibration values for machines groups 1 and 3**

| Foundation class | RMS velocity values |      | border zone |
|------------------|---------------------|------|-------------|
|                  | mm/s                | in/s |             |
| Rigid (R13)      | 2,3                 | 0,09 | A/B         |
|                  | 4,5                 | 0,18 | B/C         |
|                  | 7,1                 | 0,28 | C/D         |
| Flexible (F13)   | 3,5                 | 0,14 | A/B         |
|                  | 7,1                 | 0,28 | B/C         |
|                  | 11,0                | 0,43 | C/D         |

**Classification of vibration values for machines groups 2 and 4**

| Foundation class | RMS velocity values |      | border zone |
|------------------|---------------------|------|-------------|
|                  | mm/s                | in/s |             |
| Rigid (R24)      | 1,4                 | 0,06 | A/B         |
|                  | 2,8                 | 0,11 | B/C         |
|                  | 4,5                 | 0,18 | C/D         |
| Flexible (F24)   | 2,3                 | 0,09 | A/B         |
|                  | 4,5                 | 0,18 | B/C         |
|                  | 7,1                 | 0,28 | C/D         |

You can see vibration values graphically in the following picture.

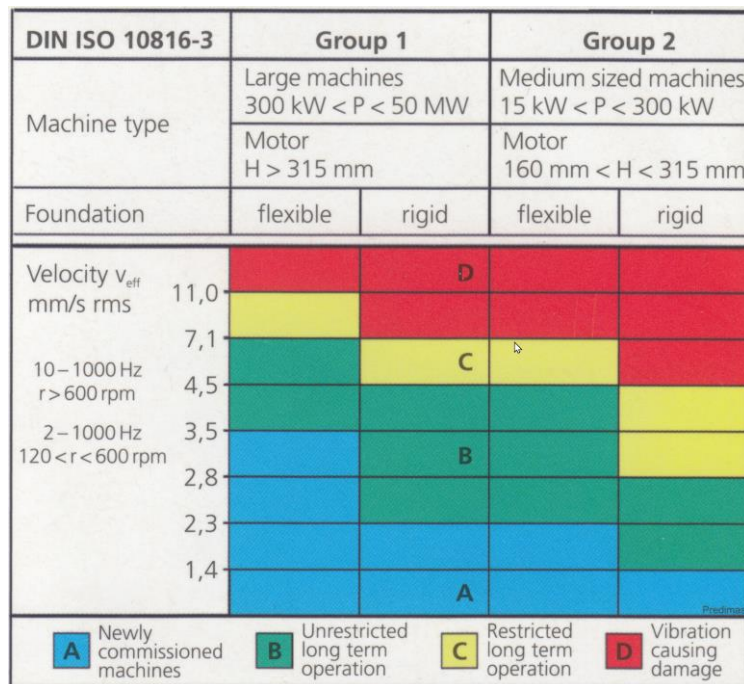

## Appendix C: Phase measurement conversions

### **Single channel measurement with tachometer**

Let's assume the time signal defined as  $y = \cos(\omega t)$ . We use the cosine function because FFT uses it too. It simplifies the calculations and understanding.

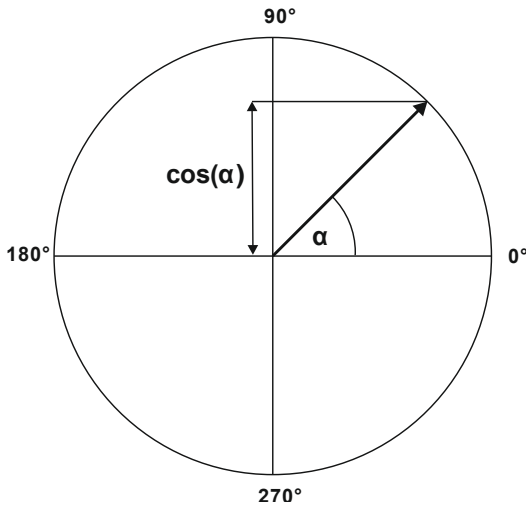

Our starting position of rotating vector  $V$  will be  $90^\circ$ , we will mark it as  $T_0$ .

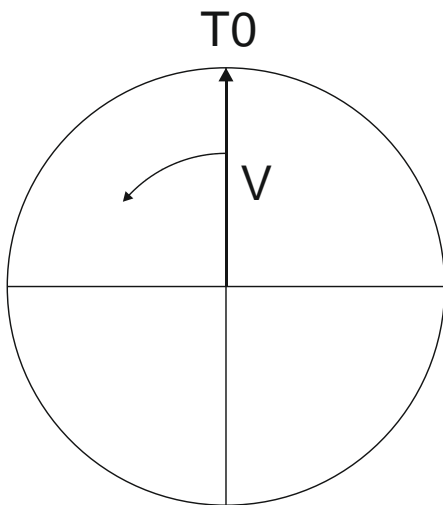

When the vector  $V$  rotates for example 3 times, then we get the time signal as follows.

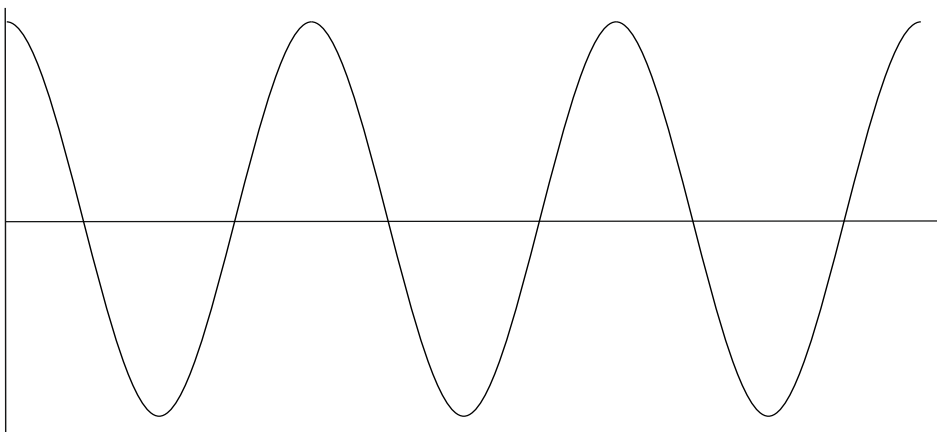

Now we assume the tacho signal. The tacho pulse we put to the T0 position.

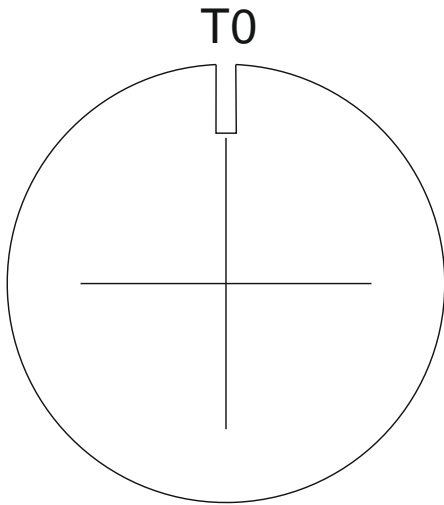

Corresponding time signal with tacho pulses is on the following picture.

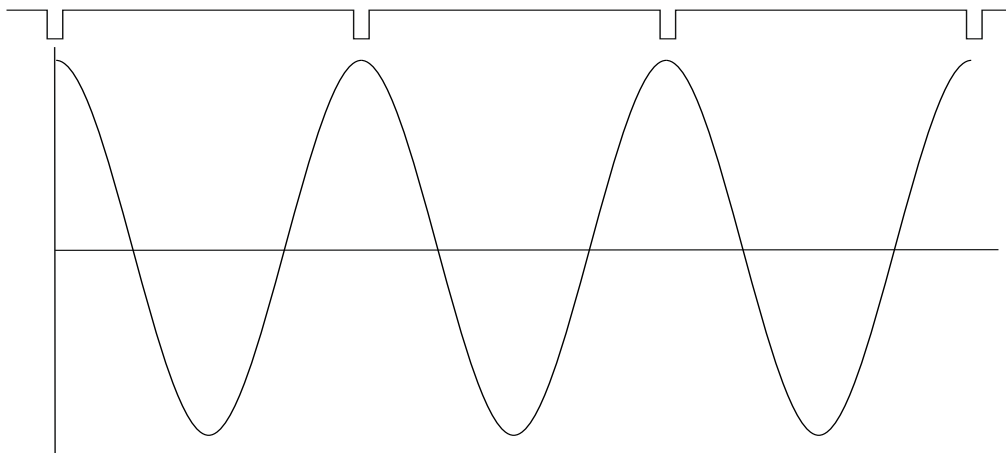

Now we begin to assume the phase shift (marked as  $\varphi$ ) of time signal vs. tacho signal. The signal formula changes to  $y = \cos(\omega t + \varphi)$ . The previous picture corresponds with  $\varphi = 0^\circ$ . And this value is displayed on the instrument screen. When the tacho pulses are in the maximum time signal positions, then phase value is equal to zero.

Now assume the  $\varphi = 45^\circ$ . We use the degrees unit to make it simple for all readers. The radians have to be used in exact math formula.

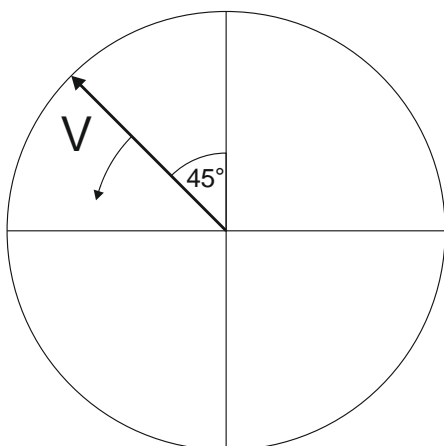

On the next picture is the corresponding time signal with tacho pulses.

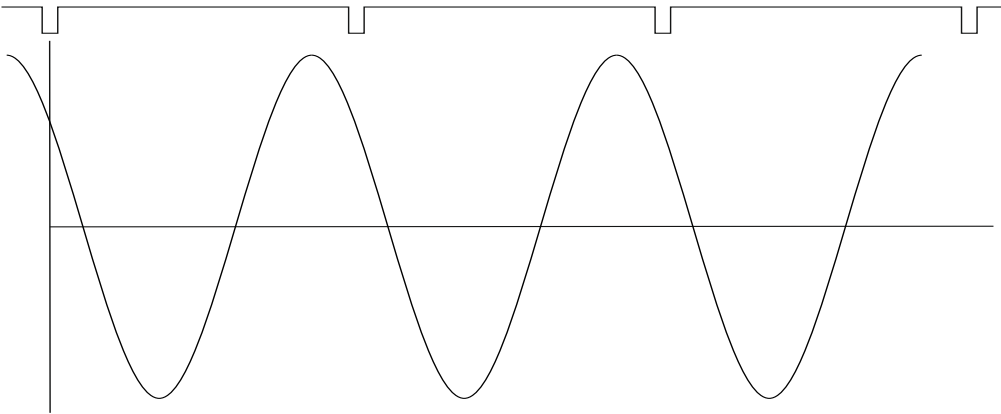

The time signal foreruns (gets ahead of) the tacho signal of the  $45^\circ$ . The  $45^\circ$  appears on instrument screen in this case.

Now we assume the  $\phi = -45^\circ$ .

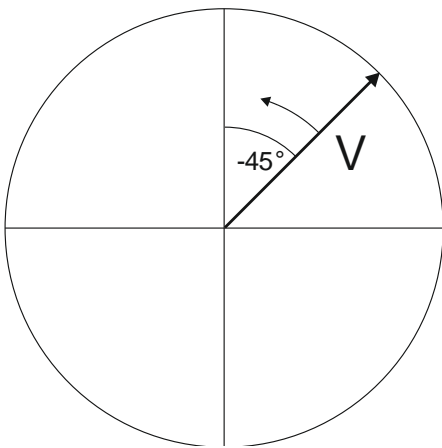

On the next picture is the corresponding time signal.

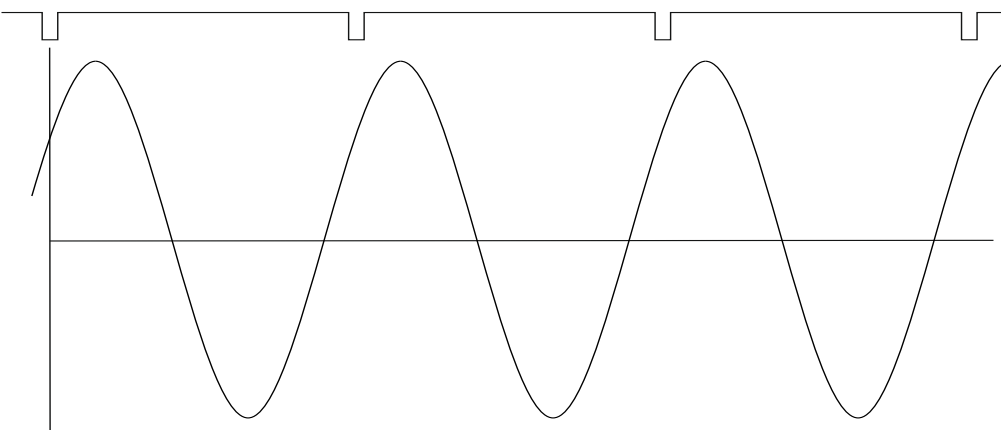

The time signal is delayed. The  $-45^\circ$  appears on instrument screen in this case.

This approach is used for single channel measurement as  $1 \times \text{amp} + \text{phase}$  and orders.



### **Dual channel measurement**

We must always define the channels of A and B. For example, we use channel 1 as A and channel 2 as B. You have to always assign the channel numbers of A and B. The A represents the input channel and B the output channel. You can imagine it as black box and you need to measure the phase response of that.

You see on the display for example this:

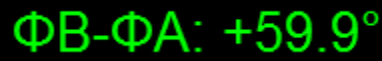

$\Phi_B - \Phi_A: +59.9^\circ$

The logic is the same as for single channel measurement. The A has the same function as tacho signal. This  $60^\circ$  means that B is ahead (foreruns) the A of  $60^\circ$ .

This approach is used for double channel measurements as phase shift.

### **Last reminder**

We talk about time signals and their positions in time in this chapter. We have used a words such as “signal is ahead”, “foreruns” and on the other side that signal is delayed.

You should always keep in mind:

**To be ahead of for example  $60^\circ$  is the same as to be delayed of  $300^\circ$ . Don't forget that we are working with periodic pure cosine time waveform.**