

**YOUR BEST PARTNER
FOR VIBRATION DIAGNOSTICS**

VIBRATION DIAGNOSTICS TOOLS AND SOFTWARE
MACHINERY CONDITION MONITORING
PREDICTIVE MAINTENANCE SYSTEMS
PORTABLE BALANCING TOOLS



MASTER THE LANGUAGE OF YOUR MACHINERY



ABOUT ADASH

The only field of business of the Adash Company is the development and production of the instruments and software for machine vibration diagnostics.

Adash Company was established in 1991 and since the beginning it has been a private company owned by its two founders. During this time many similar companies have been acquired by larger corporations. They lose the ability to make their own decisions and direct customer support is dramatically decreased.

At Adash, we remain independent and this gives us many advantages. We openly listen to feedback from customers as it gives us an opportunity to improve our products. When you contact Adash, you will be assisted by the best qualified person to answer your questions, usually the engineer who developed the product. There is professional support coming straight from Adash.

CERTIFICATES



WE EXPORT TO MORE THAN 90 COUNTRIES.

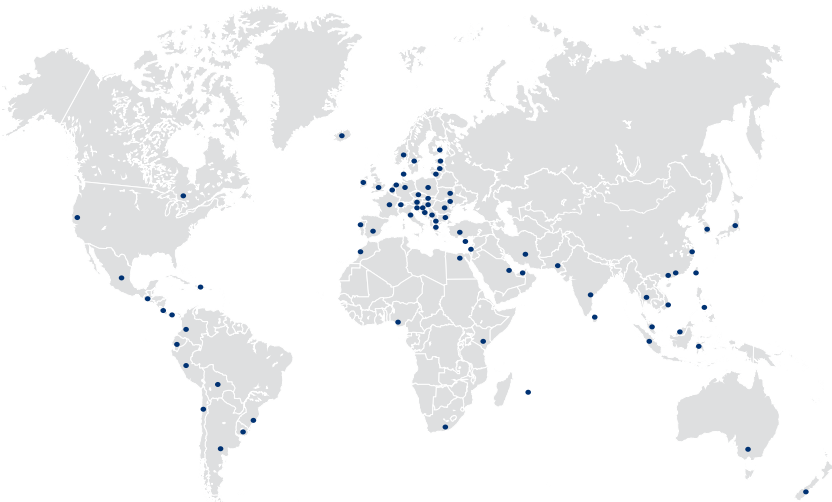

ADASH - VIBRATION DIAGNOSTICS TOOLS AND SOFTWARE SINCE 1991





- › Manufacturer of vibration diagnostics tools
- › Development of vibration diagnostics software
- › Distribution network around the world





MACHINE CONDITION MONITORING

There are more methods for evaluating a machine's condition and its faults. Besides Vibration Diagnostics you may have heard about Ultrasonic detection, Thermography, Non-destructive Testing etc. All these methods are part of Machine Condition Monitoring.

Each method has its pros and cons; it is up to your maintenance program which methods you select (or combine them) and which methods are the best for your particular machines. However, during the last few decades it has been found and proven that Vibration Diagnostics is the most efficient and reliable method for most rotating machinery.

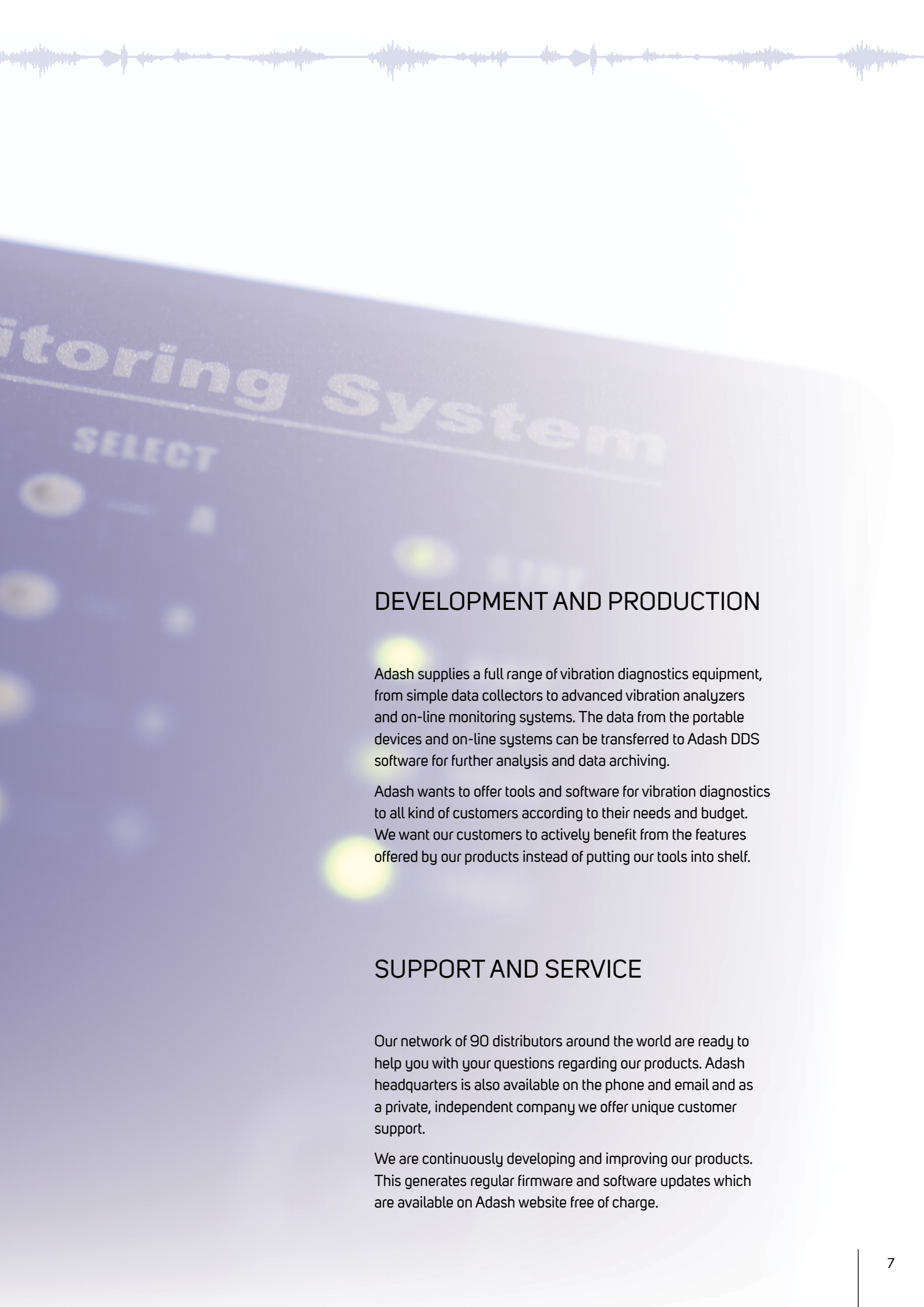

Monitoring System

DEVELOPMENT AND PRODUCTION

Adash supplies a full range of vibration diagnostics equipment, from simple data collectors to advanced vibration analyzers and on-line monitoring systems. The data from the portable devices and on-line systems can be transferred to Adash DDS software for further analysis and data archiving.

Adash wants to offer tools and software for vibration diagnostics to all kind of customers according to their needs and budget. We want our customers to actively benefit from the features offered by our products instead of putting our tools into shelf.

SUPPORT AND SERVICE

Our network of 90 distributors around the world are ready to help you with your questions regarding our products. Adash headquarters is also available on the phone and email and as a private, independent company we offer unique customer support.

We are continuously developing and improving our products. This generates regular firmware and software updates which are available on Adash website free of charge.

WHAT IS VIBRATION DIAGNOSTICS?

Vibration diagnostics is a major part of predictive machine maintenance programs. Vibration diagnostics has over the years proven to be the most effective method for checking "machinery health".

Vibration diagnostics tools are here to help us to predict the machine failures. When predictive maintenance is applied and the machines are checked regularly, machine faults can be discovered at an early stage and appropriate action can be taken. By doing so you can avoid unexpected machine shutdowns and you can prevent replacement of parts which are still in good condition.



HOW DOES IT WORK?

Running machines generate vibrations, which contain a lot of information about their condition. A vibration meter or analyzer is used to measure this vibration. The sensor needs to be mounted on an appropriate point on the machine (e.g. bearing housing). The instrument measures the vibration signal, tells you the severity of the vibrations and also possible machine fault. The most frequent faults are bearings faults, unbalance, misalignment and looseness.





WITH ADASH DEVICES YOU CAN ...

-> determine the condition of the machine according to ISO standards
-> find machine mechanical faults
-> determine the condition of roller bearings
-> control the lubrication of bearings
-> perform balancing
-> evaluate operating deflection shapes
-> use the stroboscope to check rotating parts

A4900 VIBRIO M

VIBRATION METER, ANALYZER,
DATA COLLECTOR

The A4900 - Vibrio M instrument allows you to perform all basic vibro-diagnostics measurements such as bearing condition, identification of mechanical faults and lubrication assessment.

The A4900 - Vibrio M is equipped with memory for data storage. Data memory allows you to perform off-route and route measurements. The professional software DDS for Vibrio M can be downloaded from the Adash website free of charge.

Our expert system for automatic machine fault detection is included.



Free version of DDS software
(limited database size)
New Auto Save function

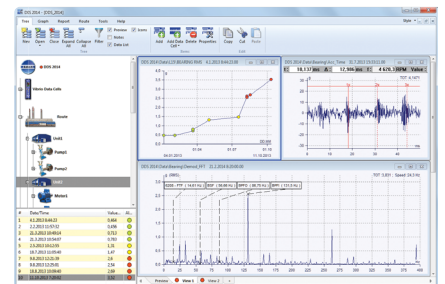

- > Quality sensor
- > Solid coiled cable
- > Strong magnetic base

MEASUREMENTS

- › ISO value [mm/s, ips]
- › Bearing value [g]
- › ISO 10816-3 included
- › Automatic speed detection

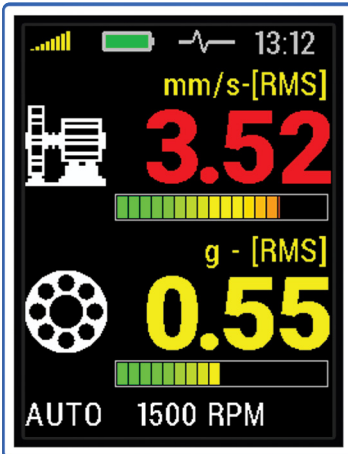

Overall values

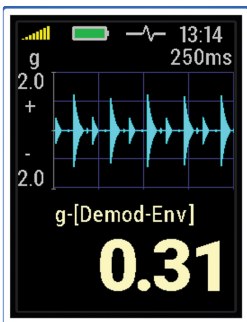

Time signal

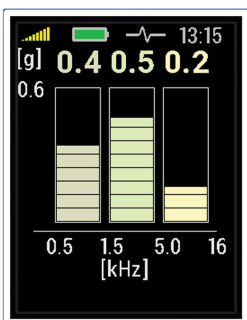

Frequency bands

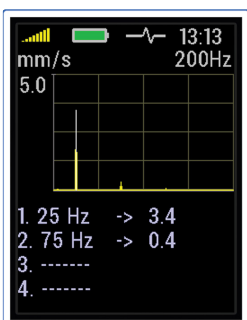

FFT Spectrum

EXPERT SYSTEM

- › Enables automatic machine fault detection on site

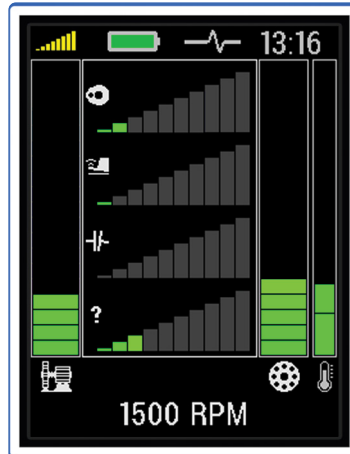

Machine OK

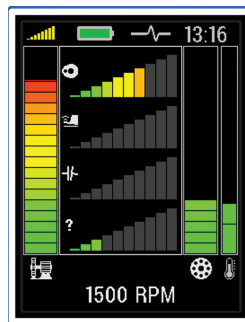

Unbalance

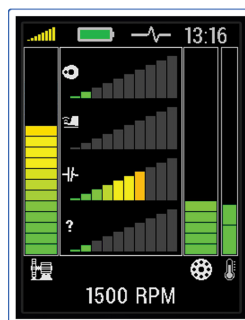

Misalignment

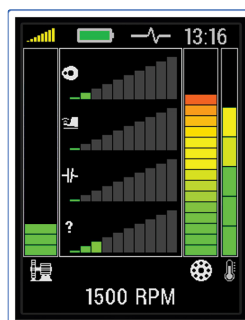

Bearing fault



SIMPLE TO USE

- › Three button operation
- › All functions are predefined
- › Expert functions for fault detection
- › Colour graphic TFT display



TOP PANEL

- › ACC ICP® - sensor input
- › IR non-contact temperature sensor
- › LED stroboscope
- › Stethoscope output



INDUSTRIAL DESIGN

- › Heavy-Duty aluminium case
- › Rubber protection bumper
- › Rechargeable Li-Ion battery
- › 16 hours of operation

A4900 VIBRIO M EX

DATA COLLECTOR IN INTRINSICALLY SAFE VERSION



The Vibrio M is now also available in an Ex version. All basic vibrodiagnostics measurements are available: Overall Values, FFT Spectrum, Time signal, Frequency bands, Route measurement or Expert system. You can listen to the signal with the headphones supplied with every unit.

The Vibrio M Ex communicates with DDS software, which you can download for free from the Adash website.



Ex certification: II 2 G Ex ib IIC T4 Gb

II	Non-mining
2	Zone 1
G	Gas atmosphere
Ex ib	Principle of protection: Intrinsic Safety EN 60079-11, Zone 1
IIC	Gas group - Acetylene, Hydrogen
T4	Temperature class 135°C
Gb	Equipment Protection Level – Zone 1 (high protection)

A4900 VIBRIO MP

PROXIMITY OPTION

The A4900 Vibrio MP contains more measurement options than the standard Vibrio M. These additional options are designed for measurement with contactless proximity sensors, which are usually used on protection systems. The Vibrio MP is connected to the buffered outputs of these systems.

DISPLACEMENT
MEASUREMENT

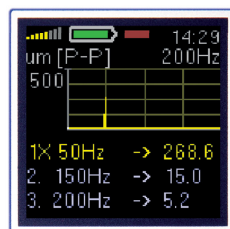

FFT Spectrum

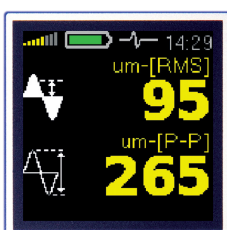

Overall values

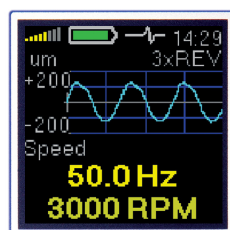

Time signal

A4910 LUBRI

OPTIMIZING THE LUBRICATION PROCESS



The A4910 Lubri is a maintenance tool used for monitoring and control of the lubrication process.

The A4910 Lubri measures the actual bearing lubrication status and informs the operator when the lubrication state is optimal.

Application of the A4910 Lubri extends the bearing lifetime and saves lubricants. Headphones can be connected to listen to the bearing condition.

The A4910 Lubri is simple to operate and also enables you to perform basic measurements and diagnoses of bearing condition.

Now the A4910 Lubri can store the data and perform route measurements as well.



Free version of DDS software
(limited database size)



- > Increase bearing lifetime
- > Basic vibrodiagnostics measurements



- > Monitoring and control of the lubrication process
- > Bearing condition state

VALUES IN TRAFFIC LIGHT COLOURS
TELL YOU WHEN TO ADD THE GREASE

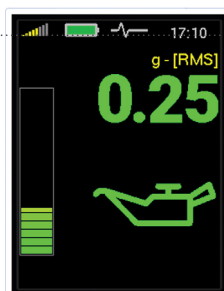

Lubrication OK

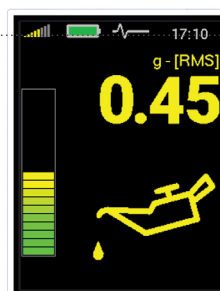

Add grease

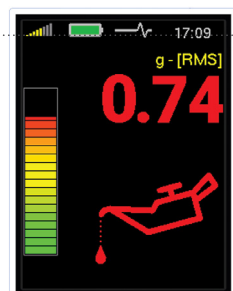

Dry bearing

A4300 VA3 Pro

3-CHANNEL, HIGH SPEED ANALYZER, DATA COLLECTOR ...



The A4300 VA3 Pro is the newest addition to our range of portable devices for vibration diagnostics.

There are 2 signal inputs and 1 tachometer/trigger input. Input 2 offers connectivity to a triaxial sensor, therefore all 3 channels can be measured simultaneously. The expert system developed by Adash can automatically detect machine faults such as unbalance, looseness, misalignment and bearing faults.

There is a non-contact IR temperature sensor (for immediate bearing temperature measurement) and a LED stroboscope/torch. The A4300 VA3 Pro is designed for one-handed operation. With a weight of just 780g and a battery life of more than 10 hours of operation, the unit is suitable for long route measurements.

The A4300 VA3 Pro instrument can be configured according to your requirements by choosing optional modules: analyzer, route, balancer, recorder, run up or ultrasound. Optional modules can be purchased also additionally and downloaded to the instrument without the need of sending it back to the factory.

- > Low weight 780 g
- > Long lasting battery
- > Ideal for route measurement
- > Route compatibility with VA4 Pro

Includes stroboscope and torch
Instrument firmware updates free of charge from Adash website

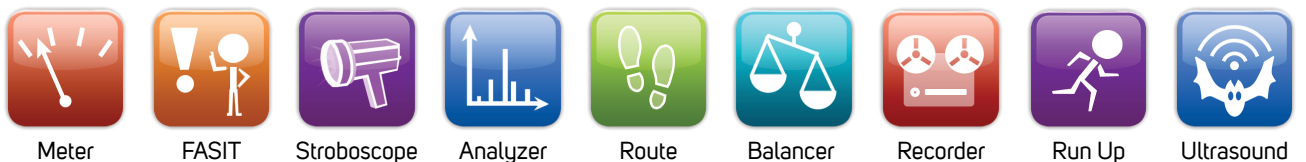



DATA PROCESSING

- › Real time FFT
- › DEMOD - ENVELOPE analysis
- › ACMT - low speed bearing analysis
- › Order analysis
- › User band pass analysis
- › RPM measurement
- › DC measurement
- › Orbit measurement

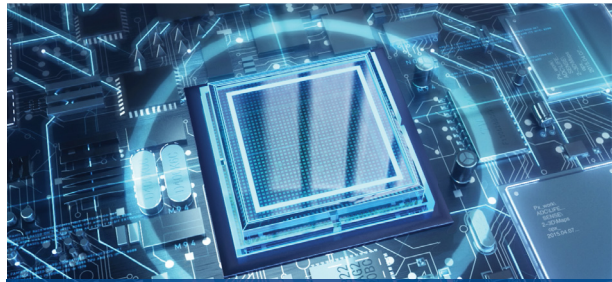

A/D CONVERSION

- › 24 Bit A/D conversion
- › 64 Bit signal processing
- › 120 dB dynamic range
- › No Auto-Gain



IDEAL FOR ROUTE MEASUREMENT

- › Heavy-Duty aluminium case
- › Removable Li-Ion battery pack
- › More than 10 hours of operation
- › Colour display 240 x 320 px
- › FFT resolution: 25600 lines
- › Route memory: 8GB



TOP PANEL

- › ACC ICP® - sensor input
- › 2 signal inputs AC/DC (IN1,IN2)
- › Input IN2 is ready for triaxial sensor (3 simultaneous channels)
- › Input for tacho/trigger
- › IR non-contact temperature sensor
- › LED stroboscope/torch
- › Mini USB for data transfer



A4300 VA3 PRO EX



- › The A4300 VA3 Pro device is available in intrinsically safe version as well.
- › For the balancing job in hazardous areas there is a laser tacho probe in intrinsically safe version available too.

II 3G ex ic op is IIC T3 Gc

A4300 VA3 PRO MEASUREMENTS MODULES

METER



11:05

CH1, 25 Hz Manual, Alarms: default

3.1 [mm/s] RMS
7.8 [mm/s] True 0-P

0.49 [g] RMS
0.70 [g] True 0-P

Stop

- Overall Vibration Values (RMS, 0-PEAK)
- FFT Spectrum
- Time Signal
- Frequency Bands
- Displacement
- Temperature

FASIT - EXPERT SYSTEM



07:48

CH1: 0.109 in/s; 0.49 g
25.0 Hz Auto

Automatic detection of possible machine faults:

- Unbalance
- Misalignment
- Looseness
- Bearing faults

Stop

STROBOSCOPE



14:25



1486.0 RPM
24.77 Hz

Back Menu Start

Switch on the stroboscope to visually "freeze" the machine movement and check its rotating parts. Speed of the machine can also be detected.

BALANCER



12:47

/balancing01 - Run 2
Measurement with trial done

Trial [g]: 45
Amplitude [mm/s RMS]: 19.0
Phase [°]: +145
Speed [RPM]: 1500
DFA: 501
DFP [°]: +179

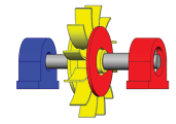

Back Menu Start

Balancer allows you to perform one or two plane balancing job of rotating parts such as industrial fans, blowers, spindles etc.

ANALYZER



13:33

/Meas01 done

4/4 select 1/1-Hz

RMS 3.68 mm/s

RMS 0.074 g 1/1-Hz

TIME t: 0 ms; Y: 1.23 mm/s 1/1-Hz

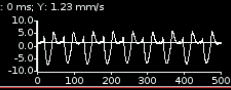

SPEC f: 0 Hz; A: 0.064 mm/s RMS 4/4-Hz

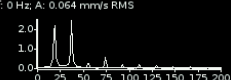

Back Menu Start/S

Select the type of the measurement (from simple overall values through FFTs and time signals to more advanced measurements with Proximity probes such as Orbits), set up the measurement settings according to your requirements (frequency range, sampling, units etc.) and take all the predefined measurements simultaneously (up to 3 channels).





ROUTE



13:43

```

/Route P1
  ✓Plant1/Unit1/Pump1
  ✓Plant1/Unit1/Pump2
  ✓Plant1/Unit2/Motor1
  ✓Plant1/Unit2/Motor2
  • Plant1/Unit3/Fan1
    Plant1/Unit3/Fan2
  Plant1/Unit4/Pump1
  Plant1/Unit4/Pump2
  Plant1/Unit5/Pump1
  Plant1/Unit5/Pump2
  Plant1/Unit6/Fan1
  Plant1/Unit6/Fan2
  
```

Back Menu Ok

Route module is used for day to day data collection of your factory machinery. Simply create your route tree and take the measurements regularly.

RUN UP



09:07

```

/Trial
1/1 trend 27.07.2016 15:14:14
APS 1/1: 8.56Hz
A: 2.70 mm/s RMS
  
```

Back Menu

Similar to Analyzer mode where you can setup any measurement which you like. Run Up allows you to control the saving of data for example as soon as possible, by speed change, time change etc.

RECORDER



11:15

```

/rec done
Time: 03.06.2016 11:14:54
Length: 00:00:21
Fs [Hz]: 65536
AC1: 100 mV / g
AC2: off
AC3: off
DC1: off
DC2: off
DC3: off
Tacho: on
AC1: (-4.00; 4.00) g
  
```

Back Menu Start

Recorder mode "records" the raw signal from the sensor (it means raw signal from the machine.) This allows you to make a post processing of the signal later on your PC.

ULTRASOUND



14:31

Level: 44 dB

Shock Factor: 18

Back Menu Start

Measurement of sound unhearable for human ear – ultrasound. Typical application is air leak detection, electrical arcing or early bearing fault detection.

A4500 VA5 Pro

MOST POWERFUL 4-CHANNEL MULTIFUNCTIONAL ANALYZER



- > Large touchscreen
- > Backlit keyboard



- Built in camera
- Thermal imaging camera
- Ultrasound detection

The A4500 - VA5 Pro is the first instrument on the market, which combines vibration analysis, thermal imaging and ultrasound detection.

It is a leading device for performing measurements in the field of machinery vibration analysis.

VA5 Pro contains all basic measurement modes and measurement possibilities. Additionally the VA5 Pro enables the connection of a thermal imaging camera for infrared thermography analysis including saving and transfer of IR images into DDS software. The VA5 Pro is equipped also with standard camera for potential machinery images and their later usage in reports. The device is newly equipped with mode for motor current signature analysis, which is a method for electric motors diagnostics.

The A4500 - VA5 Pro is suitable for engineers dealing with machinery diagnostics, on side balancing and for service and inspection activities.



TOP PANEL

INPUT CHANNELS

- › 4 AC, ICP®(On/Off), +/- 12 V pp
- › 4 DC process values, +/- 24 V
- › 1 TACHO

A/D CONVERSION

- › 24 Bit A/D conversion
- › 64 Bit signal processing
- › 120 dB dynamic range
- › No Auto-Gain

USB 2.0

- › High speed data transfer

HEADPHONES

- › Listening to vibration signal



BACKLIT KEYBOARD

- › VA5 Pro analyzer is equipped with backlit keyboard. This offers very comfortable operation of the device even in darker places with lower visibility.



DATA PROCESSING

- › FFT 3 276 800 lines in real time
- › Frequency range up to 90 kHz
- › 20 hours recording of 4 channels
- › Demodulation - envelope analysis, Order analysis
- › ACMT - low speed bearing analysis
- › User defined frequency bands

EXPERT SYSTEM - FASIT

- › Automatic machine fault detection
- › ISO 10816-3 included
- › Bearing database included

A4500 VA5 Pro MEASUREMENT MODES

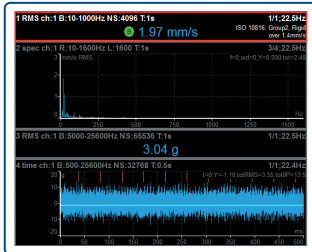

ANALYZER

- › 4 channels simultaneously

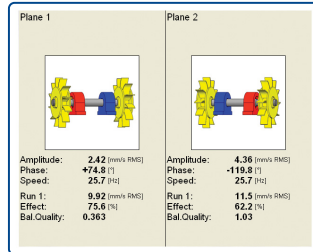

BALANCER

- › Intuitive graphical balancing procedure

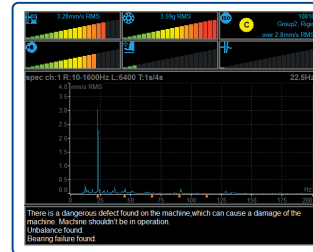

EXPERT SYSTEM

- › Automatic fault detection

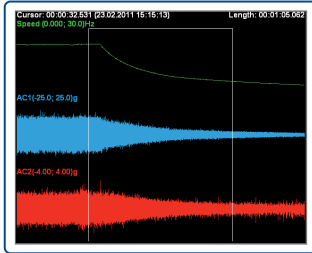

RECORDER

- › 4 channels recording
- › 20 hours signal recording

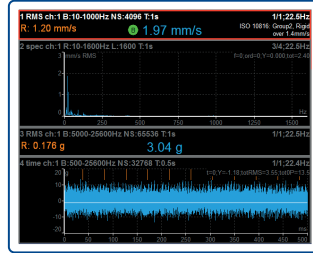

ROUTE

- › 8000 measuring points
- › DDS software

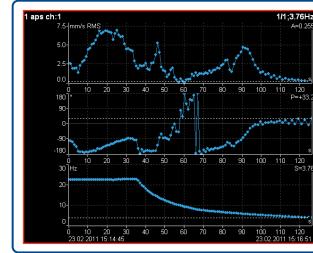

RUN UP/COAST DOWN

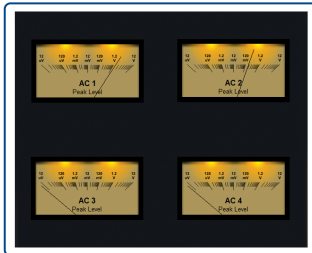

STETHOSCOPE

- › Listening of vibration signal

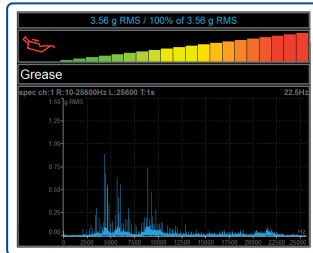

LUBRI

- › Monitoring and control of lubrication process

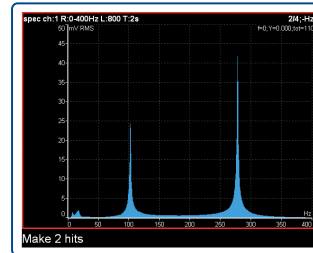

BUMP TEST

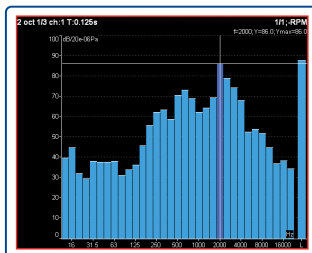

OCTAVE ANALYSIS

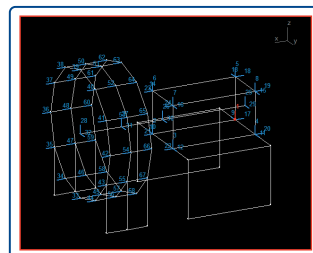

ADS

- › Animated deflection shapes

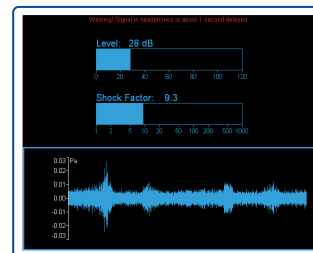

ULTRASOUND

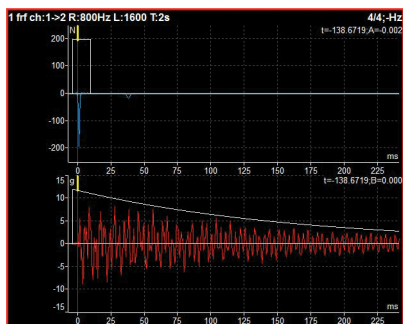
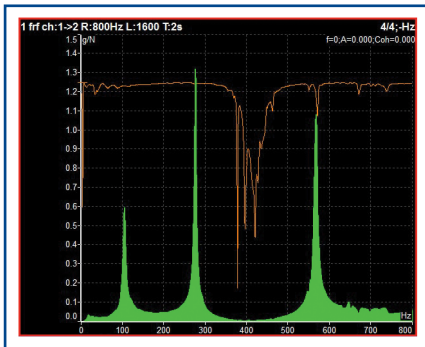

FREQUENCY RESPONSE FOR MODAL ANALYSIS

- › The A4500 VA5 Pro enables to measure frequency response for modal analysis purposes. It is attractive substitute for large systems, which are usually used for modal analysis measurements.
- › Data are exported in UFF format. They are easily imported to every modal analysis software.

```

Type:          frf
              freerun single
Input:         1
Window:       transient
Shift[ms]:    -4
Length[ms]:   14
Output:       2
Window:       exponential
Shift[ms]:    -4
Length[ms]:   500
Result Type:  H1
Range[Hz]:    800
              fs=2048Hz
Lines:        1600
              t=2s,df=0.5Hz
Avg:          4
              total t=5s
Overlap:      50%
              Save
  
```

```

Trigger Mode:  single
Runup Mode:   time
Speed Change[Hz]: 1.00
Time Change[s]: 1
Trigger Source: amplitude
Pretrig[%]:   25
Ampl Trig Channel: 1
Ampl Trig Level[N]: -25
External Trig Edge: rising
External Trig Level[V]: 1
              Save
  
```

RECORDER MODE - WHEN IT IS USEFUL

Let's say you are going to measure a big industrial blower to find out its behavior during run up. You place the sensor on the machine and set up your measurement. Then you ask the operator to run it and he starts the machine. After a few seconds you realize that you have set your measurements incorrectly and you ask the operator to stop the machine and run it again. But his answer is: "I am sorry sir, the control system will not allow me to run it again, we cannot stop the production now, you have to come over here next month." This could be a problem for you, couldn't it? With the Recorder mode you will avoid such a situation.

Just place the sensor on the machine, run the Recorder mode and record the raw signal during the run up of the machine. Later on, you can analyze this record in the office. In other words you can set any measurement which you like and play this recording again and again to get the required results.

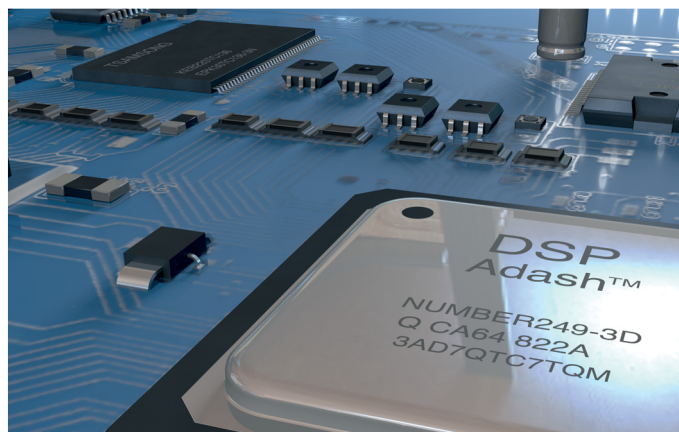

RAW SIGNAL RECORDING

- › Record the raw signal when you are not sure about the setting. Post-analyze the recorded signal later in the office.
- › With the A4500 VA5 Pro you can record up to 4 channels simultaneously.
- › A4410 Virtual Unit software for post-analyzing is possible to download from Adash website free of charge.
- › 20 hours signal recording (4 channels, 64 kHz sampling frequency).

VA5 PRO – NEW MEASUREMENT MODES

THERMAL IMAGING



Thermal imaging camera gives you another sense. Find overheated bearings, loose electrical connections, blocked pipes on heat exchangers and other industrial problems.

IR camera has 384 x 288 pixels resolution with -10 to 250 °C temperature range.



CAMERA



Built-in camera helps you to organize maintenance jobs. Take a picture of a machinery with suspicions visible fault such as oil leak, loose part or other fault. Pictures can be stored into DDS software for further action. Camera has 5 MPx resolution and autofocus.



LARGE TOUCHSCREEN



MOTOR CURRENT SIGNATURE ANALYSIS



Motor current signature analysis is a useful tool for electric motors inspection. Especially for detection of broken rotor bars, air gap eccentricity, shorted turns in stator windings and power quality.



A4404 SAB

POCKET ANALYZER



The A4404 - SAB is a pocket sized 4 channel vibration analyzer.

- Connect the A4404 - SAB to any computer by USB and use the unit for data analysing, collecting and the recording of vibration signals. The instrument is enhanced by modules for dynamic balancing, measurement of run up and coast down and acoustic measurement mode. The instrument is equipped with an expert system developed by Adash, which automatically detects machinery faults.

The instrument is powered directly by USB connection so no external power is needed.



Connect A4404 SAB to your laptop and get all functions of 4 channel analyzer VA5 Pro



Free download of VA5 Pro - Virtual Unit software enables you to try all functions of the analyzer on your computer

VA5 PRO - VIRTUAL UNIT SOFTWARE

POCKET SIZE 4 CHANNEL VIBRATION ANALYZER
Input channels: 4 AC, ICP® (ON/OFF), 4 DC, 1 TACHO



A4950 STROBO

STROBOSCOPE



Stroboscope enables to ostensibly stop rotating or generally periodic (reciprocating) motion of a machine. It allows also to find out the speed of rotation or to perform synchronized measurements without having to use reflective markers on the shaft.

The A4950 stroboscope uses three ultra-bright LEDs with optical system as a source of flashes. The device is equipped with a colour graphic display and 3 operational buttons. Operation is very easy and intuitive. Two standard or rechargeable AA batteries are used for powering. The A4950 stroboscope can be used also as a tachometer by connecting an external speed probe.



- > Flashing frequency range from 0.5 Hz to 500 Hz
- > Control of the flash duration



Flashing controlled by internal or external triggering

A4802

SENSOR SIMULATOR



The A4802 Sensor Simulator device behaves like a standard ICP® acceleration sensor with a sensitivity of 100 mV/g. The unit generates precise amplitude levels on 80 Hz and 8 kHz frequencies. The unit A4802 enables the user to check measurement precision and functionality of analyzers, vibration meters, protection and monitoring systems.



Quick check of cables, analyzers and monitoring systems

A4801

- > Simulates the acceleration sensor 100mV/g
- > Two output connectors - MIL, BNC

A3716

ON-LINE MONITORING SYSTEM - IT HAS NEVER BEEN EASIER!

The A3716 is a powerful online monitoring system for rotating machinery. The A3716 system can operate as an independent monitoring system or it can be used as an extension of an existing protection system.



WiFi connection



Adaptive data acquisition algorithm



A3716-3U

- > 16 channels AC
- > 16 channels DC
- > 4 TACHO inputs
- > 16 BNC buffered sensor signal outputs
- > 16 programmable relay outputs
- > 16 programmable 4-20 mA outputs

The A3716 module contains 16 AC, 16 DC and 4 TACHO inputs. All channels are measured simultaneously. The A3716 modules can be easily combined to create a system with more channels.



Example of use - 3 pieces of A3716 2U

SET UP AND CONTROL

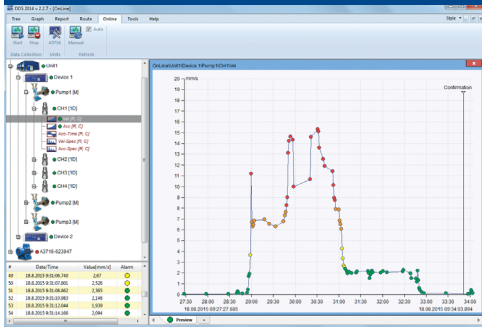

- › The set up and control of the A3716 is done by the DDS software. The set up has never been easier. The only thing you need to do is to create the tree of machines, measurement points and required readings and assign them to appropriate channels. Then you just press START and the readings are taken automatically.
- › The new data acquisition control system was developed for the A3716. Now the unit reads the vibration continuously, not only at predefined time intervals. The adaptive algorithm saves the readings to the database.
- › The A3716 unit continuously monitors the required machines and adaptively saves the readings to the data storage computer. The data is accessible from various workstations for control and analysis.
- › The great advantage of the DDS software is its very easy set-up. There is no difficult installation of the server anymore and no complicated set-up of parameters. The demands for transfer and data storage are minimized.

APPLICATION SCHEME OF A3716 UNITS

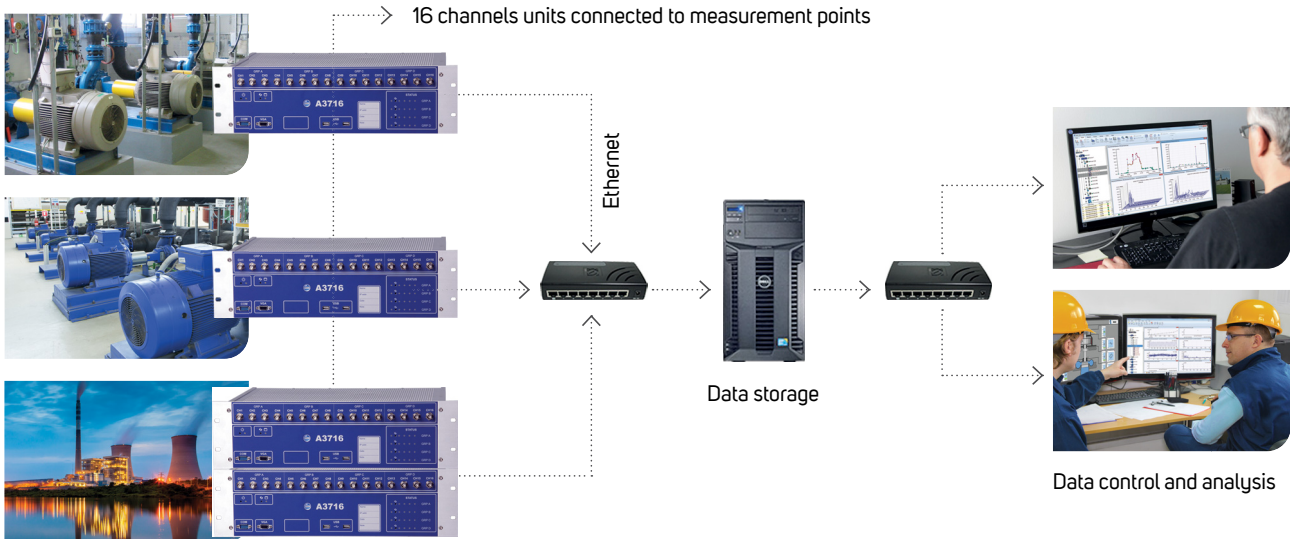

A3900

1-CHANNEL ONLINE SYSTEM



The A3900 is a simple one channel online monitoring system. The measured value is displayed on the front panel and transferred to the control system through the 4-20 mA current loop output. The A3900 unit includes one programmable output "ALARM" relay.

A3900

- › 1 channel, selectable value: [mm/s] / [ips] / [g]
- › Display of values
- › 4-20 mA current loop output
- › Relay output
- › Setup by PC

A3800

COMPACT SIZE ON-LINE MONITORING SYSTEM

- > Optional number of input channels
- > Compact size, DIN rail mounting
- > Adaptive algorithm of data acquisition
- > Remote multichannel analyzer

+ WiFi connection

The A3800 unit is the compact size on-line monitoring and diagnostic system. It is designed to increase machine reliability. The small size of the A3800 enables to mount it directly on the DIN rail.

The optional number of channels (4, 8, 12, 16) is available on the A3800 unit. The same number of AC and DC channels are always available. The 4 tacho sensors can be used in 16 channel option. The number of channels is determined by the license file. When the user wants to increase the number of channels, then only the new licence file is written to unit memory. No unit disassembling is required.

Each group of 4 channels measures fully simultaneously. Individual groups of 4 channels are multiplexed.



A3800

- > 4 - 16 channels AC
- > 4 - 16 channels DC
- > 1 - 4 TACHO inputs

APPLICATION SCHEME OF A3800 UNITS

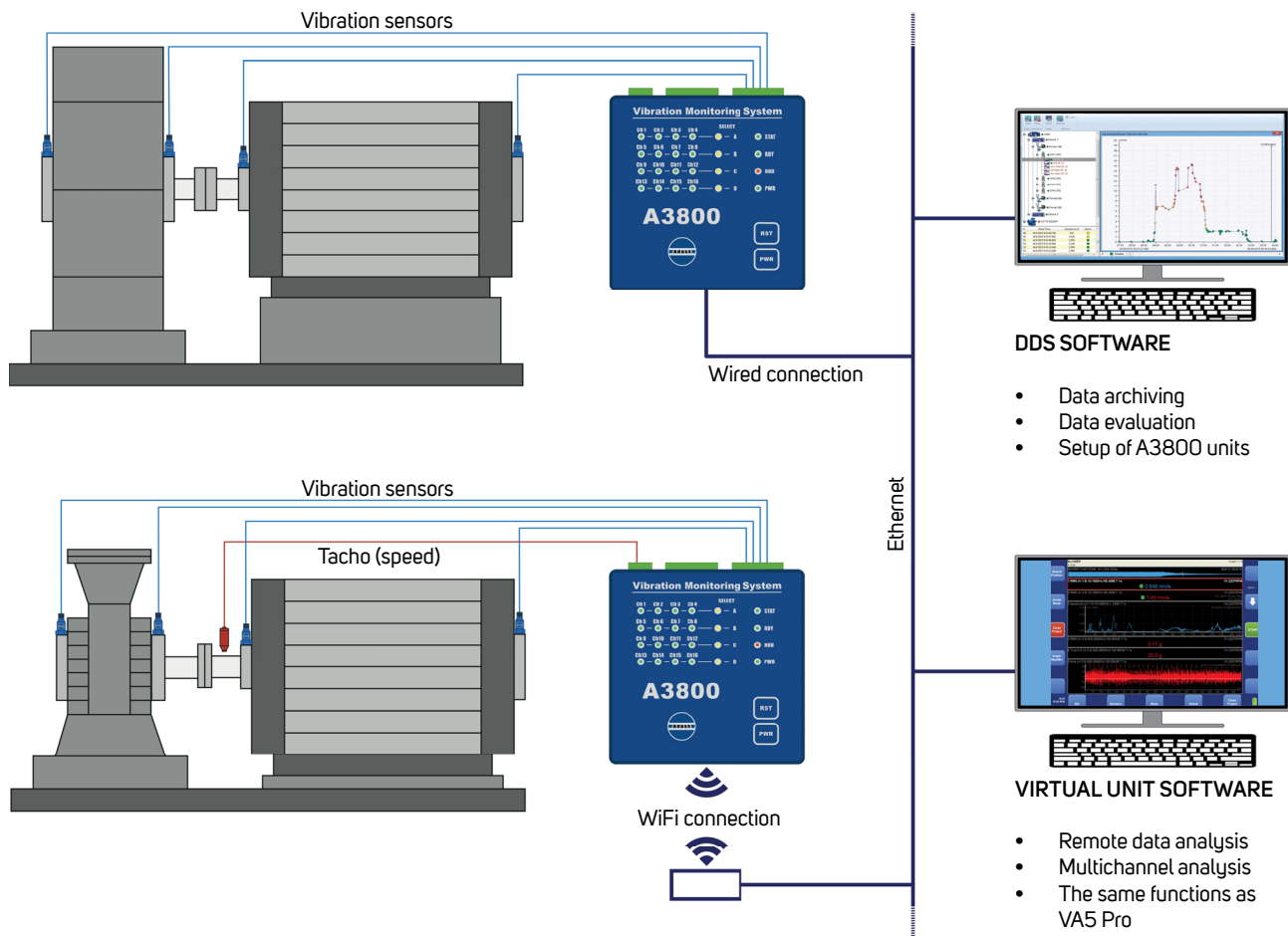

The A3800 unit can be also used as a powerful multichannel analyzer. The setting and control is made by VA4 Pro - Virtual Unit software (free download).



A3800 - TOP PANEL



A3800 - BOTTOM PANEL

DDS SOFTWARE

A POWERFUL TOOL FOR DATA STORING AND EVALUATION

The Digital Diagnostics System software represents a powerful tool for storage and evaluation of vibration and technical diagnostics data. It allows the user to connect and work with data collected by portable data collectors and on-line monitoring systems. In the full configuration, it includes all the functions necessary for data transfer, analysis and data storage.

DDS software communicates with all Adash vibration meters and analyzers and also with the online monitoring systems, so there is just one program needed for all analysis performed with Adash devices!

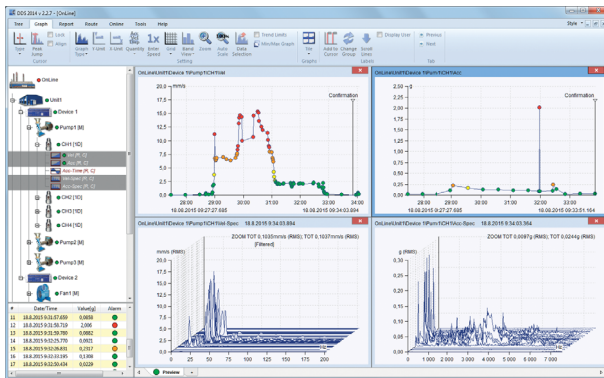

Limit values



- > User friendly
- > High reliability

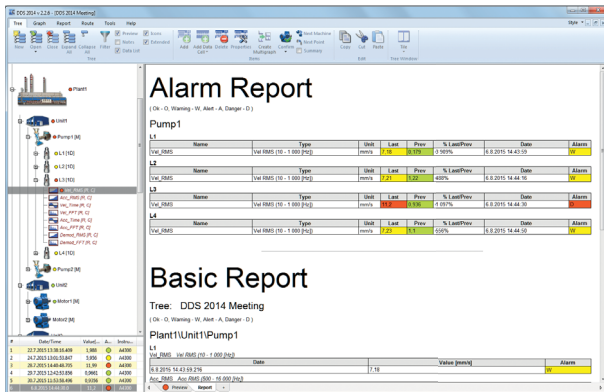

Report



Software updates free of charge
No annual fees

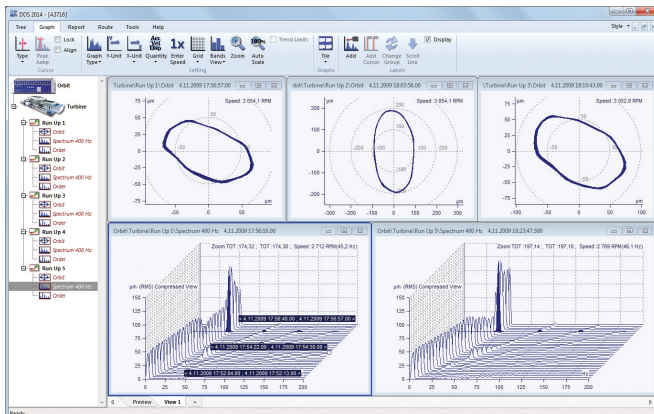

On-line

ADS SOFTWARE

VIZUALIZATION OF VIBRATION MOVEMENT

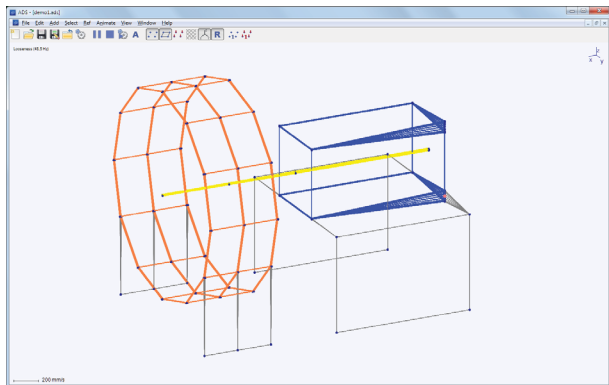

The Animated Deflection Shapes software is based on the method of operating deflection shapes.

This means that we visualize the vibrations of the machine by animation. During the animation the vibration movement is slowed down to very low frequency and the amplitude of the motion is increased so we can see the vibration.

It is a combination of vibration measurement and software processing. The output of the method is vibration movement animation on one forcing frequency or on multiple forcing frequencies.

The output of the method is easily understandable for everybody.



Immediate visualization of the vibration movement

ROUTE DOWNLOADER

SEND THE ROUTE TO TECHNICIAN ON THE OTHER SIDE OF THE WORLD



Route Downloader is a simple tool for Route transfer. DDS software can create the Route tree as one small file. You can send this file through email to your technician who is far away and who does not have an access to DDS software. He will load the Route tree to his data collector through Route Downloader and will take the readings. Then he will create again one file in the Route Downloader and send you this file (with measured data) back to you. This file will be read by DDS and measured data will be stored into your DDS Route tree.



Route Downloader is compatible with all Adash portable devices.



Adash

Hlubinska 1379/32
702 00 Ostrava
Czech Republic

tel.: +420 596 232 670

info@adash.com

www.adash.com

© Adash 2023

MASTER THE LANGUAGE OF YOUR MACHINERY

